

**Toshiba Personal Computer
Satellite
Maintenance Manual**

TOSHIBA CORPORATION

Copyright

© 2009 by Toshiba Corporation. All rights reserved. Under the copyright laws, this manual cannot be reproduced in any form without the prior written permission of Toshiba. No patent liability is assumed with respect to the use of the information contained herein.

Toshiba Personal Computer Satellite Maintenance Manual

First edition May. 2009

Disclaimer

The information presented in this manual has been reviewed and validated for accuracy. The included set of instructions and descriptions are accurate for the Satellite Series at the time of this manual's production. However, succeeding computers and manuals are subject to change without notice. Therefore, Toshiba assumes no liability for damages incurred directly or indirectly from errors, omissions, or discrepancies between any succeeding product and this manual.

Trademarks

IBM is a registered trademark, and OS/2 and PS/2 are trademarks of IBM Corporation.

Microsoft, MS-DOS, Windows, DirectSound and DirectMusic are registered trademarks of Microsoft Corporation.

Intel and Pentium are registered trademarks, and SpeedStep is a trademark of Intel Corporation.

Sound Blaster is a registered trademark of Creative Technology Ltd.

Centronics is a registered trademark of Centronics Data Computer Corporation.

Photo CD is a trademark of Eastman Kodak.

All other properties are trademarks or registered trademarks of their respective holders.

Preface

This maintenance manual describes how to perform hardware service maintenance for the Toshiba Personal Computer Satellite, referred to as the Satellite Series in this manual.

The procedures described in this manual are intended to help service technicians isolate faulty Field Replaceable Units (FRUs) and replace them in the field.

SAFETY PRECAUTIONS

Four types of messages are used in this manual to bring important information to your attention. Each of these messages will be italicized and identified as shown below.

DANGER: “Danger” indicates the existence of a hazard that could result in death or serious bodily injury if the safety instruction is not observed.

WARNING: “Warning” indicates the existence of a hazard that could result in bodily injury if the safety instruction is not observed.

CAUTION: “Caution” indicates the existence of a hazard that could result in property damage if the safety instruction is not observed.

NOTE: “Note” contains general information that relates to your safe maintenance service.

Improper repair of the computer may result in safety hazards. Toshiba requires service technicians and authorized dealers or service providers to ensure the following safety precautions are adhered to strictly.

Be sure to fasten screws securely with the right screwdriver. If a screw is not fully fastened, it could come loose, creating a danger of a short circuit, which could cause overheating, smoke or fire.

If you replace the battery pack or RTC battery, be sure to use only the same model battery or an equivalent battery recommended by Toshiba. Installation of the wrong battery can cause the battery to explode.

The manual is divided into the following parts:

- Chapter 1 Hardware Overview describes the Satellite Series system unit and each FRU.
- Chapter 2 Troubleshooting Procedures explains how to diagnose and resolve FRU problems.
- Chapter 3 Test and Diagnostics describes how to perform test and diagnostic operations for maintenance service.
- Chapter 4 Replacement Procedures describes the removal and replacement of the FRUs.
- Appendices The appendices describe the following:

- Handling the LCD module
- Board layout
- Pin assignments
- Keyboard scan/character codes
- Key layout
- Screw torque list
- Reliability

Conventions

This manual uses the following formats to describe, identify, and highlight terms and operating procedures.

Acronyms

On the first appearance and whenever necessary for clarification, acronyms are enclosed in parentheses following their definition. For example:

Read Only Memory (ROM)

Keys

Keys are used in the text to describe many operations. The key top symbol as it appears on the keyboard is printed in **boldface** type.

Key operation

Some operations require you to simultaneously use two or more keys. We identify such operations by the key top symbols separated by a plus (+) sign. For example, **Ctrl + Pause (Break)** means you must hold down **Ctrl** and at the same time press **Pause (Break)**. If three keys are used, hold down the first two and at the same time press the third.

User input

Text that you are instructed to type in is shown in the boldface type below:

DISKCOPY A: B:

The display

Text generated by the computer that appears on its display is presented in the typeface below:

```
Format complete  
System transferred
```

Table of Contents

Chapter 1 Hardware Overview

1.1	Features	1-1
1.2	2.5-inch HDD.....	1-9
1.3	DVD Super Multi (+-R Double Layer).....	1-10
1.4	Power Supply	1-11
1.5	Batteries	1-13
1.5.1	Main Battery	1-13
1.5.2	Battery Charging Control.....	1-13
1.5.3	RTC Battery	1-14

Chapter 2 Troubleshooting Procedures

2.1	Troubleshooting Introduction	3
2.2	Troubleshooting Flowchart.....	4
2.3	Power Supply Troubleshooting.....	9
2.4	Display Troubleshooting.....	14
2.5	Keyboard Troubleshooting	17
2.6	External USB Devices Troubleshooting.....	19
2.7	TouchPad Troubleshooting.....	22
2.8	Speaker Troubleshooting	24
2.9	Wireless LAN Troubleshooting.....	26
2.10	Camera troubleshooting	28
2.11	Bluetooth Troubleshooting	30
2.12	3 in 1 card Troubleshooting	32
2-13	HDD/SSD troubleshooting process	34
2-14	CRT failure troubleshooting process	36
2-15	LAN Troubleshooting.....	38
2-16	MIC troubleshooting process.....	40

2-17	BUTTON troubleshooting process	41
2.18	Modem troubleshooting process	44
2.19	Express card troubleshooting process	46
2.20	HDMI troubleshooting process	48
2.21	E-SATA troubleshooting process	50
2.22	Optical Drive Troubleshooting	52

Chapter 3 Tests and Diagnostics

3.1	The Diagnostic Test	3
3.2	Executing the Diagnostic Test	4
3.3	Display Configuration	8
3.4	Audio sound Test	9
3.5	Fan ON/OFF Test.....	9
3.6	Main Battery Charge Test.....	11
3.7	FDD Test.....	11
3.8	Memory Check.....	14
3.9	Keyboard Test.....	14
3.10	Mouse (Pad) Test	16
3.11	LCD Pixels Mode Test.....	17
3.12	Magnetic switch Test	18
3.13	LAN Test.....	20
3.14	RTC Test.....	23
3.15	BUTTON Test.....	24
3.16	1st HDDTest	26
3.17	RDMI Test	27
3.18	WDMI Test	28

Chapter 4 Replacement Procedures

4.1	General	4-1
	Safety Precautions	4-2
	Before You Begin	4-4
	Disassembly Procedures	4-5
	Assembly Procedures	4-5
	Tools and Equipment	4-6
	Screw Tightening Torque	4-6
	Colors of Screw Shanks	4-7
	Symbols of Screws on the Laptop Body	4-7
	Symbol examples	4-7
4.2	Battery	4-8
	Removing the Battery Pack	4-8
	Installing the Battery Pack	4-9
4.3	HDD	4-10
	Removing the HDD	4-10
	Installing the HDD	4-11
4.4	Memory	4-12
	Removing the Optional Memory	4-12
	Installing the Optional Memory	4-13
4.5	ODD	4-14
	Removing the ODD Bay Module	4-14
	Installing the ODD Bay Module	4-15
	Disassembling the ODD Drive	4-15
	Assembling the ODD Drive	4-16
4.6	Keyboard Cover and Keyboard	4-17
	Removing the Keyboard Cover and Keyboard	4-17
	Installing the Keyboard Cover and Keyboard	4-19
4.7	Logic Upper Assembly	4-20
	Removing the Logic Upper Assembly	4-20
	Installing the Logic Upper Assembly	4-22
4.8	Function Board	4-23

Removing the Function Board	4-23
Installing the function board	4-23
4.9 Bluetooth Card	4-24
Removing the Bluetooth card	4-24
Installing the Bluetooth card	4-25
4.10 Touch Pad Button Board and Bracket.....	4-26
Removing the Touch pad button board and bracket	4-26
Installing the Touch Pad Button Board and Bracket	4-27
4.11 Speakers	4-28
Removing the Speakers.....	4-28
Installing the the Speakers	4-28
4.12 Display Assembly	4-29
Removing the Display Assembly.....	4-29
Installing the Display Assembly	4-30
4.13 Thermal Fan	4-31
Removing the Thermal Fan.....	4-31
Installing the Thermal Fan	4-31
4.14 Motherboard.....	4-32
Removing the Motherboard	4-32
Installing the Motherboard.....	4-34
4.15 USB Board	4-36
Removing the USB Board.....	4-36
Installing the USB Board	4-36
4.16 ODD Board	4-37
Removing the ODD Board.....	4-37
Installing the ODD Board	4-37
4.17 Thermal Moduleand VGA Board (Optional).....	4-38
Removing Removing the Thermal Module and VGA Board	4-38
Installing the VGA Board and Thermal Module	4-39
4.18 CPU.....	4-41
Removing the CPU	4-41
Installing the CPU.....	4-42

4.19	WLAN Card.....	4-43
	Removing the WLAN Card	4-43
	Installing the WLAN Card.....	4-43
4.20	Modem Card (Optional).....	4-44
	Removing the Modem Card.....	4-44
	Installing the Modem Card	4-44
4.21	LCD Bezel Assembly.....	4-45
	Removing the LCD Bezel Assembly	4-45
	Installing the LCD Bezel	4-47
4.22	LCD Module	4-50
	Removing the LCD Module.....	4-50
	Installing the LCD Module	4-53
4.23	CMOS Board and Microphone (Optional)	4-53
	Removing the CMOS Board and Microphone.....	4-53
	Installing the CMOS Board and Microphone	4-53

Figures

Figure 4.1	Removing the Battery Pack	4-8
Figure 4.2	Removing the HDD door.....	4-10
Figure 4.3	Removing the HDD plate	4-11
Figure 4.4	Removing the RAM door	4-12
Figure 4.5	Removing the RAM from the laptop	4-13
Figure 4.6	Removing the ODD Bay module.....	4-14
Figure 4.7	Removing the bracket from the ODD drive.....	4-15
Figure 4.8	Removing the keyboard cover	4-17
Figure 4.9	Removing screws and releasing hooks from the keyboard.....	4-18
Figure 4.10	Removing the keyboard	4-19
Figure 4.11	Removing the screws from the bottom of the laptop.....	4-20
Figure 4.12	Removing six screws from under the keyboard.....	4-21
Figure 4.13	Detaching cables from under the keyboardp	4-22
Figure 4.14	Removing the function board	4-23

Figure 4.15	Removing the Bluetooth card	4-24
Figure 4.16	Removing the screws from the touch pad button board	4-26
Figure 4.17	Removing the touch pad bracket	4-27
Figure 4.18	Removing the speakers	4-28
Figure 4.19	Removing the display assembly.....	4-29
Figure 4.20	Removing the hinge brackets.....	4-30
Figure 4.21	Removing the thermal fan from the logic lower assembly	4-31
Figure 4.22	Removing the motherboard from logic lower assembly.....	4-32
Figure 4.23	Removing the DC IN connector and cable	4-33
Figure 4.24	Picking up the motherboard.....	4-34
Figure 4.25	Aligning the motherboard connectors.....	4-35
Figure 4.26	Installing the DC IN connector	4-36
Figure 4.27	Removing the USB Board	4-37
Figure 4.28	Removing the ODD Board.....	4-38
Figure 4.29	Removing the Thermal Module	4-39
Figure 4.30	Removing the VGA Board.....	
Figure 4.31	Reapply Shinetsu 7726 grease on the thermal module and remove any release papers	4-40
Figure 4.32	Removing the CPU	4-41
Figure 4.33	Removing the WLAN card	4-43
Figure 4.34	Removing the modem card	4-44
Figure 4.35	Removing the LCD Bezel Assembly	4-45
Figure 4.36	Taking out the hinge wall	4-46
Figure 4.37	Removing the bezel from the hinge wall	4-46
Figure 4.38	Reroute the cables	4-47
Figure 4.39	Pressing the bezel hinge wall.....	4-48
Figure 4.40	Pressing the bezel downside hook	4-49
Figure 4.41	Pressing the left and right side of the bezel	4-49
Figure 4.42	Pressing the bezel upside hooks.....	4-50
Figure 4.43	Removing the LCD Module from the LCD cover assembly	4-51
Figure 4.44	Removing the LCD Hinge Assembly	4-52
Figure 4.45	Removing the LVDS cable	4-53

Figure 4.46	Installing the LCD Hinge Assembly.....	4-53
Figure 4.47	Removing the LCD Module from the LCD cover assembly	4-53
Figure 4.48	Removing the CMOS board and Microphone	4-53

Appendices

Appendix A	Handling the LCD Module	A-1
Appendix B	Board Layout	B-1
Appendix C	Pin Assignments	C-1
Appendix D	Keyboard Scan/Character Codes	D-1
Appendix E	Key Layout	E-1
Appendix F	Series Screw Torque List.....	F-1
Appendix G	Reliability	G-1

Chapter 1

Hardware Overview

Chapter 1 Contents

1.1	Features	1-1
1.2	2.5-inch HDD	1-10
1.3	DVD Super Multi (+-R Double Layer).....	1-11
1.4	Power Supply	1-13
1.5	Batteries.....	1-15
1.5.1	Main Battery	1-15
1.5.2	Battery Charging Control	1-15
1.5.3	RTC Battery.....	1-16

Figures

Figure 1-1A ID Parts Description Placement Part A..... 1-6
Figure 1-2 SATA HDD 1-10
Figure 1-3 DVD Super Multi Drive 1-11

Tables

Table 1-1 HDD Specifications 1-10
Table 1-2 DVD Super Multi Drive Specifications 1-11
Table 1-3 Quick/Normal Charging Time 1-15

1.1 Features

The Toshiba Satellite L550/L550D is a full-size PC notebook equipped with a Dual Core Processor, providing high-speed processing capabilities and advanced features. The computer employs a lithium ion battery that allows it to be battery-operated for long periods of time. The display uses 17.3-inch WXGA LCD panel. Many features can be Built To Order (BTO) to customize the system for each user.

The computer has the following features:

Processor (BTO)

The computer is equipped with one of the following Intel[®] processors:

- Intel[®] Dual Core[™] 2 Duo Processor
- Intel[®] Penryn/Celeron Processor Support

Memory (BTO)

The computer has two SODIMM slots which come standard with 512MB/1GB/2GB/4GB, accepting BTO for your memory requirements. It can incorporate up to either 4GB or 8 GB of main memory depending on the models. It supports DDR2 at 667MHz and 800MHz.

Battery Pack

The computer is powered by one rechargeable and removable lithium ion battery pack. The capacity can be either 3-cell, 6-cell or 12-cell, depending on the model of the computer.

RTC Battery

The internal RTC battery backs up the Real Time Clock and calendar.

Hard Disk Drive (HDD) (BTO)

The computer accommodates a 9.5 mm HDD with the following storage capacities:

- 120/160/250/320 GB, S-ATA (5,400rpm)
- 160/200/320 GB, S-ATA (7,200rpm)

The computer has an optional 9.5mm SSD with the following capacities:

1 Hardware Overview Fehler! Verwenden Sie die Registerkarte 'Start', um 標題 2 dem Text zuzuweisen, der hier angezeigt werden soll. Fehler! Verwenden Sie die Registerkarte 'Start', um 標題 2 dem Text zuzuweisen, der hier angezeigt werden soll.

- 64/128 GB

Fehler! Verwenden Sie die Registerkarte 'Start', um 標題 2 dem Text zuzuweisen, der hier angezeigt werden soll. Fehler! Verwenden Sie die Registerkarte 'Start', um 標題 2 dem Text zuzuweisen, der hier angezeigt werden soll.

ODD (BTO)

- 12.7mm height DVD Super Multi drive supporting \pm R Double Layer
- 12.7mm height DVD Super Multi drive supporting \pm R Double Layer w/ Labelflash

Display

The LCD display comes with the following:

- 17.3" W (16:9) HD+ (1600x900) CSV WhiteLED

Graphics (BTO)

- Intel[®] GM45/GL40 integrated graphics display
- ATI Mobility Radeon[™] HD 4500 for external graphics support, DDR3 (256/512MB) (depending on model)

Keyboard

The computer is equipped with a Toshiba standard 360mm keyboard, which has A4 + 10key Genchaku Keyboard without stick-point. It is a Vista-compliant keyboard with optional Windows keys and application keys (except for Linux models).

Pointing Device

The integrated Wide Touch Pad and two control buttons in the palm rest allow control of the on-screen pointer and support functions such as the scrolling of windows.

External Monitor Port

The analog VGA port provides support for VESA DDC2B compatible functions. A WDDM driver is ready for Vista.

Universal Serial Bus (USB) Ports

The computer has two USB 2.0 ports along with one USB/eSATA combo port (see below). It is supported to daisy-chain a maximum of 127 USB devices. The serial data transfer rate is 480 Mbps or 12 Mbps and 1.5 Mbps. These ports support PnP installation and hot plugging.

1 Hardware Overview Fehler! Verwenden Sie die Registerkarte 'Start', um 標題 2 dem Text zuzuweisen, der hier angezeigt werden soll. Fehler! Verwenden Sie die Registerkarte 'Start', um 標題 2 dem Text zuzuweisen, der hier angezeigt werden soll.

eSATA

The external SATA or eSATA port executes high-speed data transfer to external devices and supports shielded cable lengths of up to 2 meters outside the PC. The port also provides dual USB compatibility.

Express Card Slot (BTO)

The internal Express Card slot is a universal slot. This slot supports ExpressCard 34/54 and comes with a dummy card. It also supports USB/PCI Express signals.

Bridge Media Slot

This slot allows you to insert SD, MiniSD/ MicroSD (through an adaptor), Memory Stick, Memory Stick Pro and MMC memory cards. It supports high-speed SD and SDHC. This model does not support CF, SmartMedia cards, xD or Memory Stick Duo cards.

Sound system

The integrated sound system is composed of two Realtek Azalia internal speakers, an internal microphone (BTO with internal camera), and standard Microphone-IN and Headphone-OUT ports.

Internal Camera (BTO)

It supports 0.3M and 1.0M pixels with Auto Macro and comes with a blue LED indicator. An internal microphone is BTO with the internal camera and includes echo cancellation. The camera is not a rotation type.

Headphones/Line-out Jack

This jack connects digital speakers or stereo headphones (16 ohm minimum). When connected to digital speakers or headphones, the internal speaker is automatically disabled.

Microphone/ Line-in Jack

A 3.5mm mini microphone jack enables connection of a three-conductor microphone for monaural input and also enables the connection of a stereo device for audio input.

HDMI Out Port (BTO)

Fehler! Verwenden Sie die Registerkarte 'Start', um 標題 2 dem Text zuzuweisen, der hier angezeigt werden soll. Fehler! Verwenden Sie die Registerkarte 'Start', um 標題 2 dem Text zuzuweisen, der hier angezeigt werden soll.

The HDMI 1.3 out port can connect with a Type A connector HDMI cable. The HDMI out port can send SD and HD video/audio signals.

LAN (BTO)

The computer has built-in support for 10M/100M Ethernet LAN (10/100 megabits per second, 10/100BASE-T). It employs a Realtek 8103EL for 10M/100Mbit LAN. It is pre-installed as a standard device in some markets.

Wireless LAN (BTO)

Some computers in this series are equipped with a Wireless LAN (WLAN) card. This WLAN module may come with the following types (depending on the model):

- Atheros 802.11 b/g (HB95 1x1n), b/g/n (HB93 2x2), a/b/g/n (HB92 2x2)
- Realtek 802.11 bg (8187SE)

Internal Modem (BTO)

Some models are equipped with an integrated modem. The integrated modem provides capability for data and fax communications that support the V.90 (V.92) standards and includes a modem jack for connection to the telephone line. Please note that both the V.90 and V.92 standards are only supported in the USA, Canada, United Kingdom, France, Germany and Australia - only the V.90 standard is supported in other regions. You should also be aware that the speed of data and fax transfer will depend on the analog telephone line conditions. The integrated model is only installed as a standard device in some markets. This internal modem comes with MDC 1.5 solution (Azalia interface).

Bluetooth (BTO)

Some computers in this series offer Bluetooth wireless communication functionality which eliminates the need for cables between electronic devices such as computers and printers. When implemented, Bluetooth provides wireless communication in a small space. This module is Version 2.1 + EDR (Antenna on Module type), ie – Toshiba stack support.

1 Hardware Overview Fehler! Verwenden Sie die Registerkarte 'Start', um 標題 2 dem Text zuzuweisen, der hier angezeigt werden soll. Fehler! Verwenden Sie die Registerkarte 'Start', um 標題 2 dem Text zuzuweisen, der hier angezeigt werden soll.

□ Figure 1-1A shows the computer and its system unit configuration.

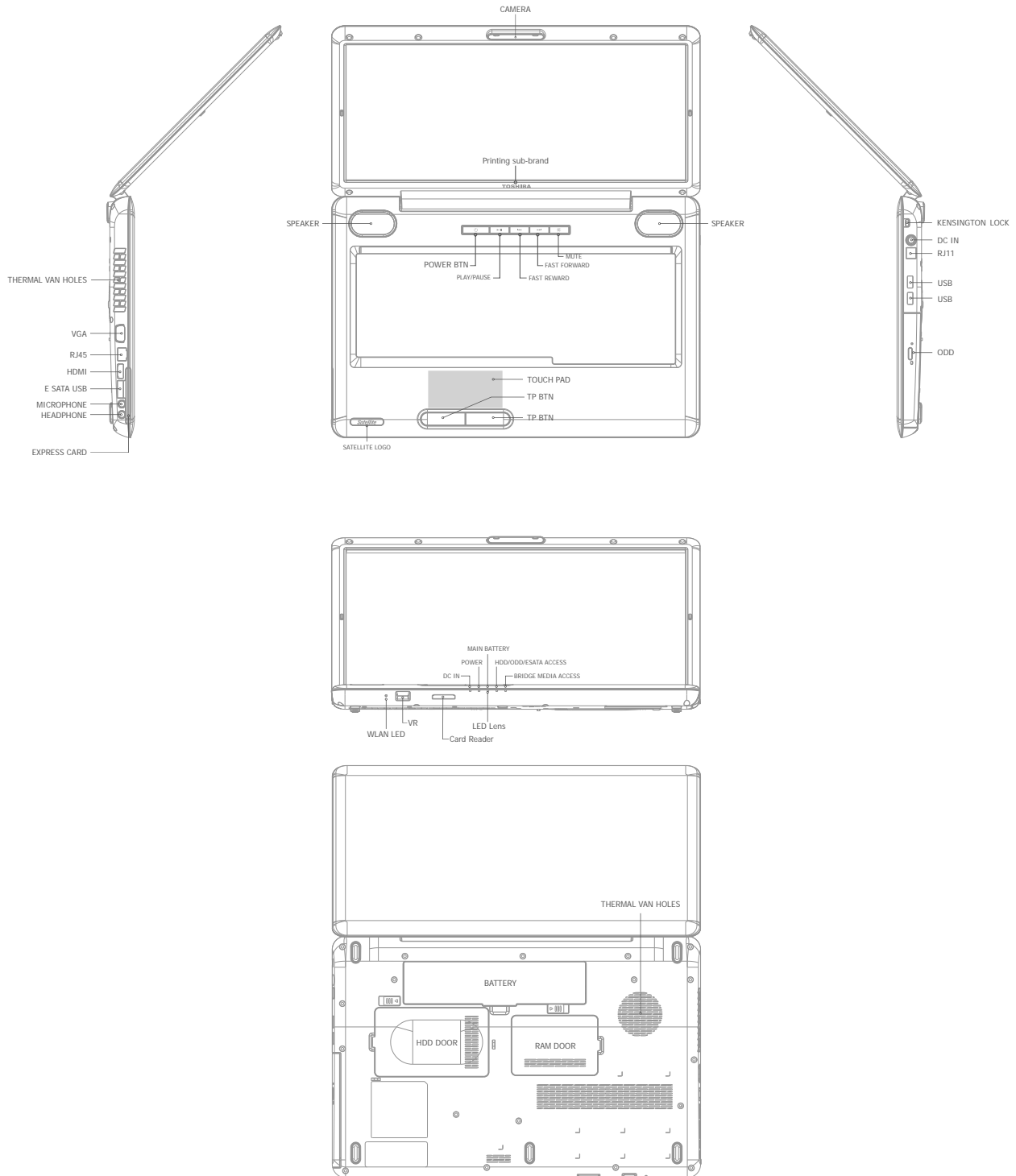
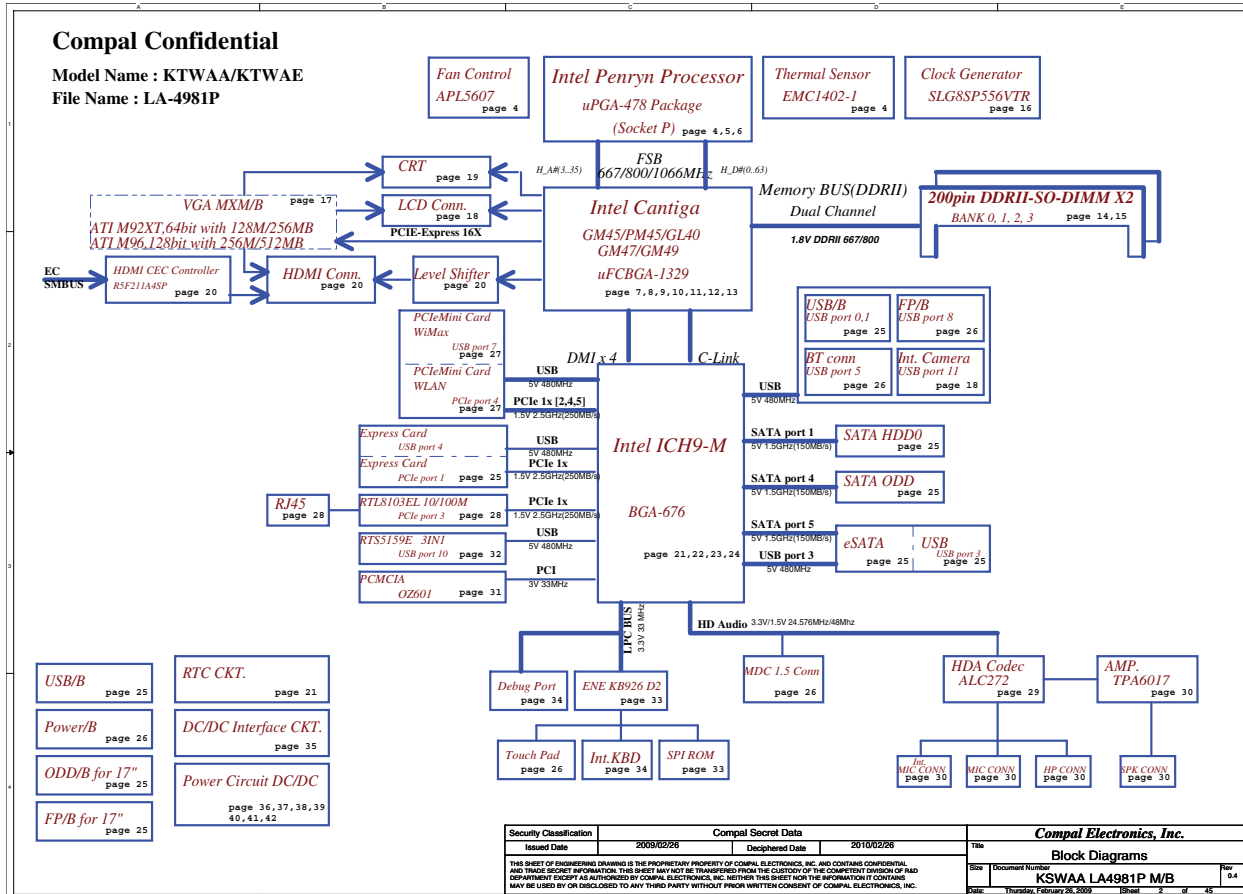

Figure 1-1A ID Parts Description Placement Part A

Fehler! Verwenden Sie die Registerkarte 'Start', um 標題 2 dem Text zuzuweisen, der hier angezeigt werden soll. Fehler! Verwenden Sie die Registerkarte 'Start', um 標題 2 dem Text zuzuweisen, der hier angezeigt werden soll.

1 Hardware Overview



1 Hardware Overview Fehler! Verwenden Sie die Registerkarte 'Start', um 標題 2 dem Text zuzuweisen, der hier angezeigt werden soll. Fehler! Verwenden Sie die Registerkarte 'Start', um 標題 2 dem Text zuzuweisen, der hier angezeigt werden soll.

The system unit of the computer consists of the following components:

Processor (BTO)

The computer is equipped with one of the following Intel[®] processors:

- Intel[®] Core[™] Duo Processor
- Intel[®] Core[™] Solo Processor
- Intel[®] Celeron[®] Processor

Memory (BTO)

The computer has two SODIMM slots which come standard with 512MB/1GB/2GB/4GB, accepting BTO for your memory requirements. It can incorporate up to either 4GB or 8 GB of main memory depending on the models. It supports DDR2 at 667MHz and 800MHz.

BIOS ROM (EEPROM)

The system BIOS and Keyboard BIOS share one single 1024KB flash ROM. The flash utility can be used to program both system and keyboard BIOS at the same time.

System Controllers

- Advanced Power Management 1.2 support
- ACPI2.0b and Windows Logo Program 3.0 compliant
- Support SMBus specification V2.0
- Hot keys for system control
- Audio volume output control
- External LED control
- Battery scope report and control
- Sticky key support
- Power switch control
- Two host interface channels support
- Supports three independent devices
- Internal Keyboard country selection

Fehler! Verwenden Sie die Registerkarte 'Start', um 標題 2 dem Text zuzuweisen, der hier angezeigt werden soll. Fehler! Verwenden Sie die Registerkarte 'Start', um 標題 2 dem Text zuzuweisen, der hier angezeigt werden soll.

Graphics Controller

- Intel® GM45/GL40 as integrated graphics solution
- ATI Mobility Radeon™ HD 4500 with DDR3 (256MB, 512MB) for external graphics solution
- DVI-D supported by conversion cable from HDMI

Express Card Controller

- Support USB/PCI Express signals
- One Express card slot 34/54

Audio Controller

- Realtek Azalia ALC272
- One Audio-in port: Mic-in/Line-in
- One Audio-out port: Headphone-out/Line-out
- Internal Microphone (with Internal Camera, MIC with echo cancellation)
- Volume control: Digital control
- Microsoft inbox audio driver support
- Hardware EQ support

Wireless LAN Controller

- Atheros 802.11 b/g (HB95 1x1n), b/g/n (HB93 2x2), a/b/g/n (HB92 2x2)
- Realtek 802.11 bg (8187SE)
- WPS supported

1 Hardware Overview Fehler! Verwenden Sie die Registerkarte 'Start', um 標題 2 dem Text zuzuweisen, der hier angezeigt werden soll. Fehler! Verwenden Sie die Registerkarte 'Start', um 標題 2 dem Text zuzuweisen, der hier angezeigt werden soll.

1.2 2.5-inch HDD

The computer contains an extremely low-profile and lightweight, high-performance HDD. The HDD incorporates a 9.5 mm magnetic disk and mini-Winchester type magnetic heads. The HDD interface conforms to Serial ATA. Storage capacities supported are 120, 160, 200, 250 and 320 GB.

The HDD is shown in Figure 1-2 and some of its specifications are listed in Table 1-1.

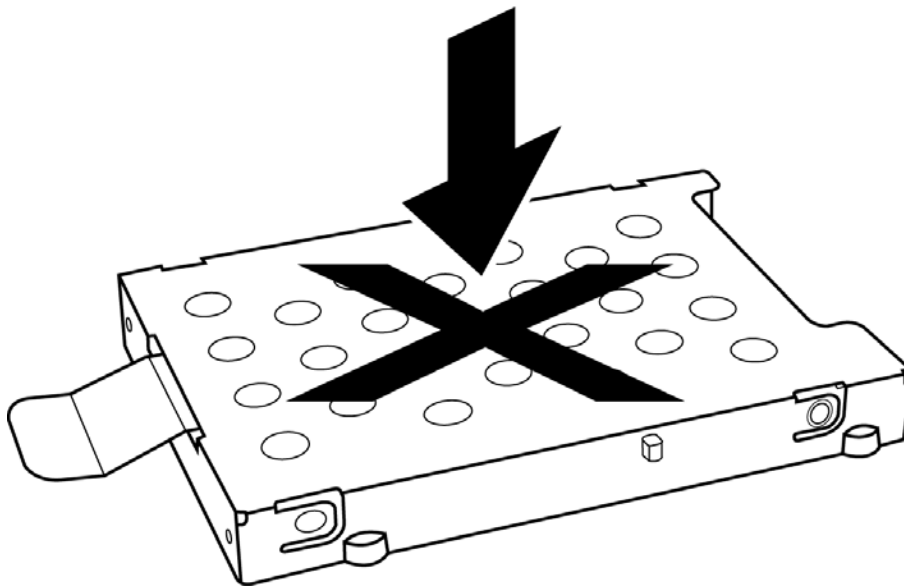

Figure 1-2 SATA HDD

Table 1-1 HDD Specifications

Item	Specifications				
Capacity (GB)	120GB	160 GB	200 GB	250 GB	320G
Rotational Speed (RPM)	5400 RPM	5400/7200 RPM	7200 RPM	5400 RPM	5400/7200 RPM
Height	9.5 mm	9.5 mm	9.5 mm	9.5 mm	9.5 mm
User Data Sectors	234,441,648	312,581,808	390,721,968	488,397,168	625,142,448
Bytes / Sector	512	512	512	512	512

Fehler! Verwenden Sie die Registerkarte 'Start', um 標題 2 dem Text zuzuweisen, der hier angezeigt werden soll. Fehler! Verwenden Sie die Registerkarte 'Start', um 標題 2 dem Text zuzuweisen, der hier angezeigt werden soll.

1.3 DVD Super Multi (+-R Double Layer)

The DVD Super Multi drive accepts 12-cm (4.72-inch) and 8-cm (3.15-inch) discs. At maximum, the drive can play back a DVD at 8x speed, read CD-ROM at 24x speed, and write CD-R at 24x speed, CD-RW at 4x speed, US CD-RW at 24x speed, High Speed CD-RW at 10x speed, DVD-R at 8x speed, DVD-RW at 6x speed, DVD+R at 8x speed, DVD+R (Double Layer) at 6x speed, DVD-R (Dual Layer) at 4x speed, DVD+RW at 8x speed and DVD-RAM at 5x speed.

The DVD Super Multi drive is shown in Figure 1-3 and its specifications are listed in Table 1-2.

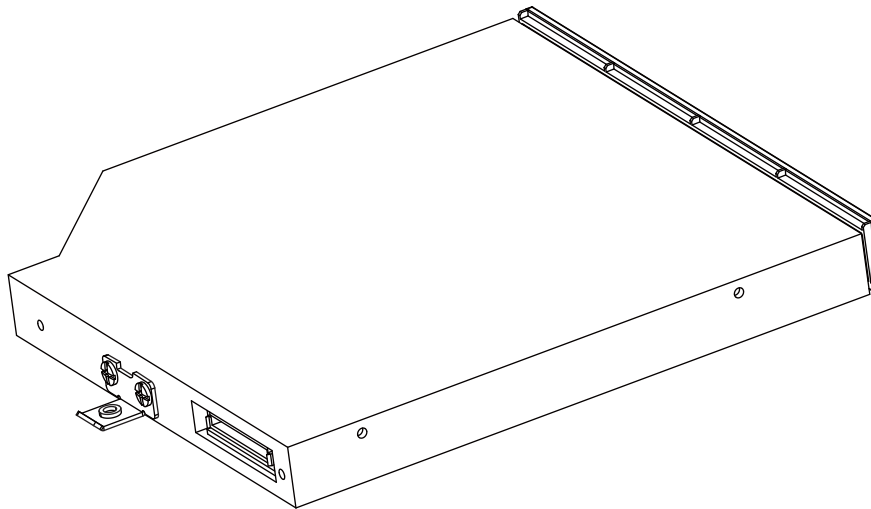

Figure 1-3 DVD Super Multi Drive

Table 1-2 DVD Super Multi Drive Specifications

Item	DVD-ROM Mode	CD-ROM Mode
Data Transfer Rate (Mbytes/s)	33.3 (U-DMA transfer mode 2) 16.6 (PIO mode 4, Multiword DMA mode 2)	
Access Time (ms)		
Average Random Access	130	130
Data Buffer Size (Mbytes)	2MB	
Formats Supported	DVD: DVD-VIDEO, DVD-ROM, DVD-R, DVD-RW, DVD-RAM, DVD+R, DVD+R (Double Layer), DVD+RW. CD:	

1 Hardware Overview Fehler! Verwenden Sie die Registerkarte 'Start', um 標題 2 dem Text zuzuweisen, der hier angezeigt werden soll. Fehler! Verwenden Sie die Registerkarte 'Start', um 標題 2 dem Text zuzuweisen, der hier angezeigt werden soll.

CD-DA, CD-ROM, CD-R, CD-RW, CD-ROMXA, Photo CD (Multi-Session), Video CD, CD-Extra (CD+), CD-Text.
--

Fehler! Verwenden Sie die Registerkarte 'Start', um 標題 2 dem Text zuzuweisen, der hier angezeigt werden soll. Fehler! Verwenden Sie die Registerkarte 'Start', um 標題 2 dem Text zuzuweisen, der hier angezeigt werden soll.

1.4 Power Supply

The power supply unit provides constant voltage (19V) for the system board and performs the following functions:

1. Power input monitor
 - Checks whether the AC adapter (DC power supply) is connected to the computer.
 - Checks whether the battery pack is connected to the computer.
 - Monitors the DC power supply input voltage (AC Adapter output voltage).
2. Power supply's internal control
 - Turns on and off the battery pack charging power supply.
 - Issues a charging current instruction to the PWM control IC of the battery pack charging power supply.
 - Controls the supply of DC power supply input (AC Adapter output) to the power supply unit.
 - Controls the supply of power to the system block (load/logic circuit side).
 - Controls forced shutdown if the power supply malfunctions.
3. Logic circuit control
 - Instructs the gate array to enable/disable tuning the power on.
 - Controls power-on/off operation.
4. Status display
 - Turns on the Power LED (in Green).
 - Battery indicator (in Green or Amber).
 - DC-IN indicator (in Green)
5. External interface
 - Performs communication through the I2C bus (via the internal EC/KBC).
 - Transfers the power supply operation mode.

1 Hardware Overview Fehler! Verwenden Sie die Registerkarte 'Start', um 標題 2 dem Text zuzuweisen, der hier angezeigt werden soll. Fehler! Verwenden Sie die Registerkarte 'Start', um 標題 2 dem Text zuzuweisen, der hier angezeigt werden soll.

6. Output monitor

- Monitors the voltage output to the system block (load/logic circuit side).
- Monitors the voltage, over-voltage, input/output current of the battery pack.
- Monitors the internal temperature of the battery pack.
- Monitors the supply voltage from the AC adapter.

Fehler! Verwenden Sie die Registerkarte 'Start', um 標題 2 dem Text zuzuweisen, der hier angezeigt werden soll. Fehler! Verwenden Sie die Registerkarte 'Start', um 標題 2 dem Text zuzuweisen, der hier angezeigt werden soll.

1.5 Batteries

The computer has the following two types of batteries:

- Main Battery Pack
- Real Time Clock (RTC) Battery

1.5.1 Main Battery

The main battery pack serves as the computer's main power source when the AC adapter is not attached. The main battery maintains the state of the computer when the AC adapter is detached.

1.5.2 Battery Charging Control

Battery charging is controlled by EC KB926. When the AC adapter and battery pack are attached to the computer, the EC KB926 controls the charge on/off state and detects a full charge.

- Battery Charge

When the AC adapter is attached, the battery is charged by off-state charge when the system is powered off or by on-state charge when it is powered on.

Table 1-3 Quick/Normal Charging Time

State	Charge Time	
Off-State Charge	3/6/12 Cell	About 4 hours max
On-State Charge	3/6/12 Cell	About 12 hours max

1 Hardware Overview Fehler! Verwenden Sie die Registerkarte 'Start', um 標題 2 dem Text zuzuweisen, der hier angezeigt werden soll. Fehler! Verwenden Sie die Registerkarte 'Start', um 標題 2 dem Text zuzuweisen, der hier angezeigt werden soll.

NOTE: The time required for normal charge depends on the power consumption by the system. Using a fluorescent lamp and frequently accessing the disk consumes more power and lengthens the charge time.

Any of the following can stop battery charge:

1. The battery becomes fully charged.
2. The AC adapter or battery pack is removed.
3. The battery or AC adapter voltage is abnormal.

Detection of full charge

A full charge is detected only when the battery is being charged by quick or normal charge. A full charge is detected when either of the following conditions is met:

1. The current in the battery charging circuit drops below the predetermined value.
2. The charging time exceeds the fixed limit.

1.5.3 RTC Battery

The RTC battery provides power to keep the current date, time and other system information in memory while the computer is turned off.

Chapter 2

Troubleshooting Procedures

Chapter 2 Contents

2.1	Troubleshooting Introduction	3
2.2	Troubleshooting Flowchart.....	4
2.3	Power Supply Troubleshooting	9
2.4	Display Troubleshooting	14
2.5	Keyboard Troubleshooting	17
2.6	External USB Devices Troubleshooting.....	19
2.7	TouchPad Troubleshooting.....	22
2.8	Speaker Troubleshooting	24
2.9	Wireless LAN Troubleshooting.....	26
2.10	Camera Troubleshooting	28
2.11	Bluetooth Troubleshooting	30
2.12	3in1 card Troubleshooting	32
2.13	HDD/SSD Troubleshooting.....	34
2.14	CRT Troubleshooting	36
2.15	LAN Troubleshooting.....	38
2.18	modem Troubleshooting.....	44
2.19	Express card Troubleshooting	46
2.20	HDMI Troubleshooting	48
2.21	E-SATA Troubleshooting.....	50
2.22	Optical Drive Troubleshooting.....	52

Figures

Figure2-1	Troubleshooting flowchart (1/2).....	5
Figure2-1	Troubleshooting flowchart (2/2).....	6
Figure 2-2	Power Supply Troubleshooting Process.....	9
Figure 2-3	Display troubleshooting process	14
Figure 2-4	Keyboard troubleshooting process	17
Figure 2-5	External USB device troubleshooting process	19
Figure 2-6	TouchPad troubleshooting process.....	22
Figure 2-7	Speaker troubleshooting process	24
Figure 2-8	Wireless LAN troubleshooting process.....	26
Figure 2-9	Camera troubleshooting process	28
Figure 2-10	Bluetooth troubleshooting process.....	30
Figure 2-11	3 in 1 card troubleshooting process.....	32
Figure 2-12	HDD/SSD troubleshooting process.....	34
Figure 2-13	CRT troubleshooting process	36
Figure 2-14	LAN troubleshooting process	38
Figure 2-15	MIC troubleshooting process	40
Figure 2-16	BUTTON troubleshooting process	42
Figure 2-17	Modem troubleshooting process	44
Figure 2-18	Express card troubleshooting process	46
Figure 2-19	HDMI troubleshooting process	48
Figure 2-20	E-SATA troubleshooting process	50
Figure 2-21	Optical Drive Troubleshooting.....	52

Tables

Table 2-1	Battery LED	10
Table 2-2	DC-IN LED	11

2.1 Troubleshooting Introduction

Chapter 2 describes how to determine if a Field Replaceable Unit (FRU) in the computer is causing the computer to malfunction. The FRUs covered are:

- | | | | |
|-------------|-----------------|-------------------|-----------|
| 1. Display | 7. Wireless LAN | 13. Express card | 19. 3IN 1 |
| 2. HDD/SSD | 8. Camera | 14. HDMI | |
| 3. Keyboard | 9. Bluetooth | 15. E-SATA | |
| 4. USB HDD | 10. Headphone | 16. Optical drive | |
| 5. Touchpad | 11. MIC | 17. LAN | |
| 6. Speaker | 12. Modem | 18. BUTTON | |

The Diagnostics Disk operations are described in Chapter 3. Detailed replacement procedures are given in Chapter 4.

The following tools are necessary for implementing the troubleshooting procedures:

1. Diagnostics Disk (Repair and Sound Repair)
2. Phillips screwdriver (2 mm)
3. 6mm nut driver (for the helix screw nuts on the rear ports for CPU door)
4. 2DD or 2HD formatted work disk for floppy disk drive testing
5. Sycard (EXPRESS CARD test card)
6. Cleaning kit for floppy disk drive troubleshooting
7. Cleaning kit for optical drive troubleshooting
8. Multimeter
9. External monitor
10. USB compatible keyboard
11. Multimedia sound system with line-in and line-out ports
12. Headphones
13. USB test module and USB cable
14. Music CD

15. MIC module and MIC line

2.2 Troubleshooting Flowchart

If you know the location of the malfunction, turn directly to the appropriate section of this chapter. If the problem is unspecified, use the flowchart in Figure 2-1 as a guide for determining which troubleshooting procedures to execute. Before performing any troubleshooting procedures, verify the following:

- Ask the user if a password is registered, if it is, ask him or her to enter the password.
- Verify with the customer that Toshiba Windows XP/Vista is installed on the hard disk. Operating systems that were not preinstalled by Toshiba can cause the computer to malfunction.
- Make sure all optional equipment is removed from the computer.

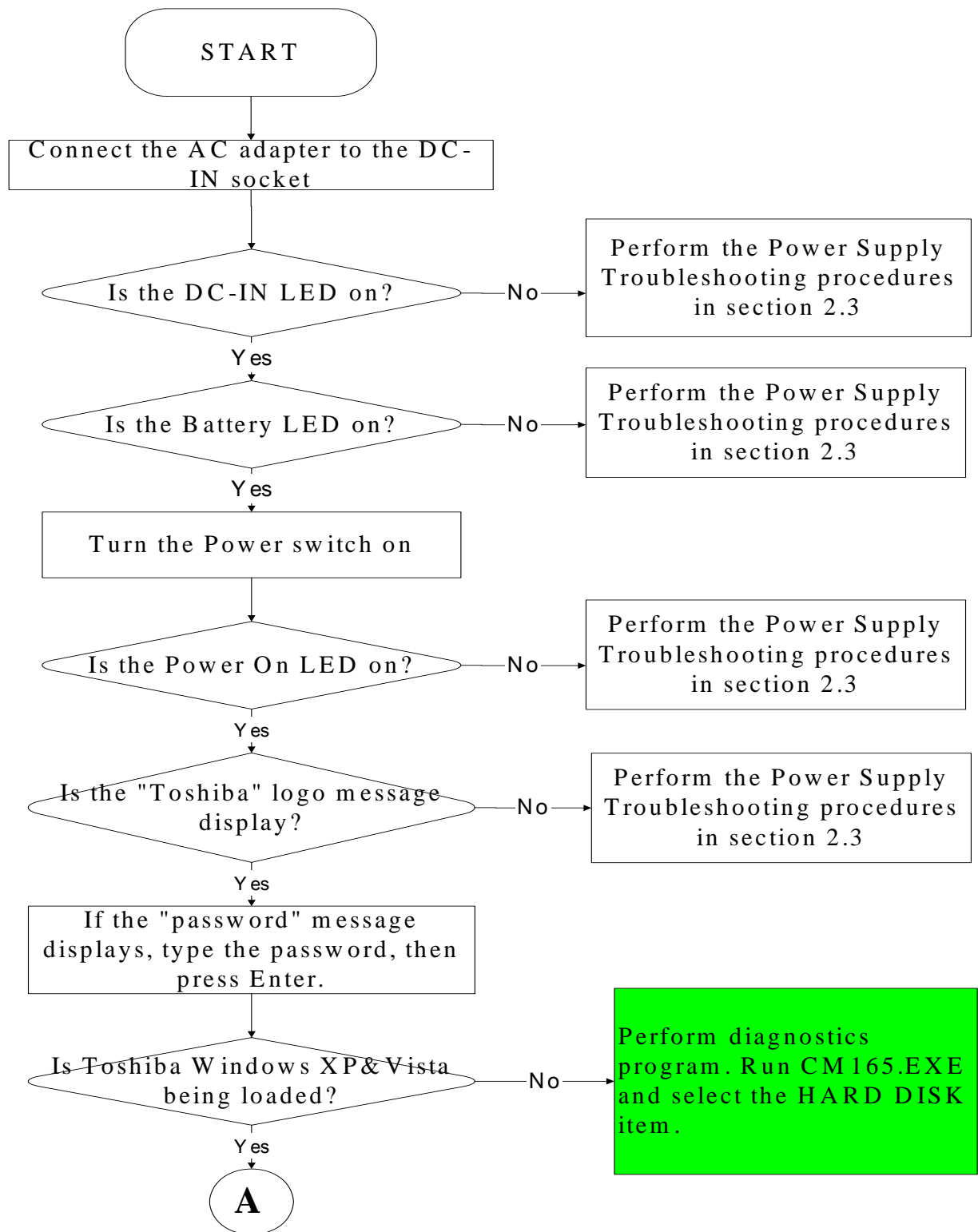

Figure 2-1 Troubleshooting flowchart (1/2)

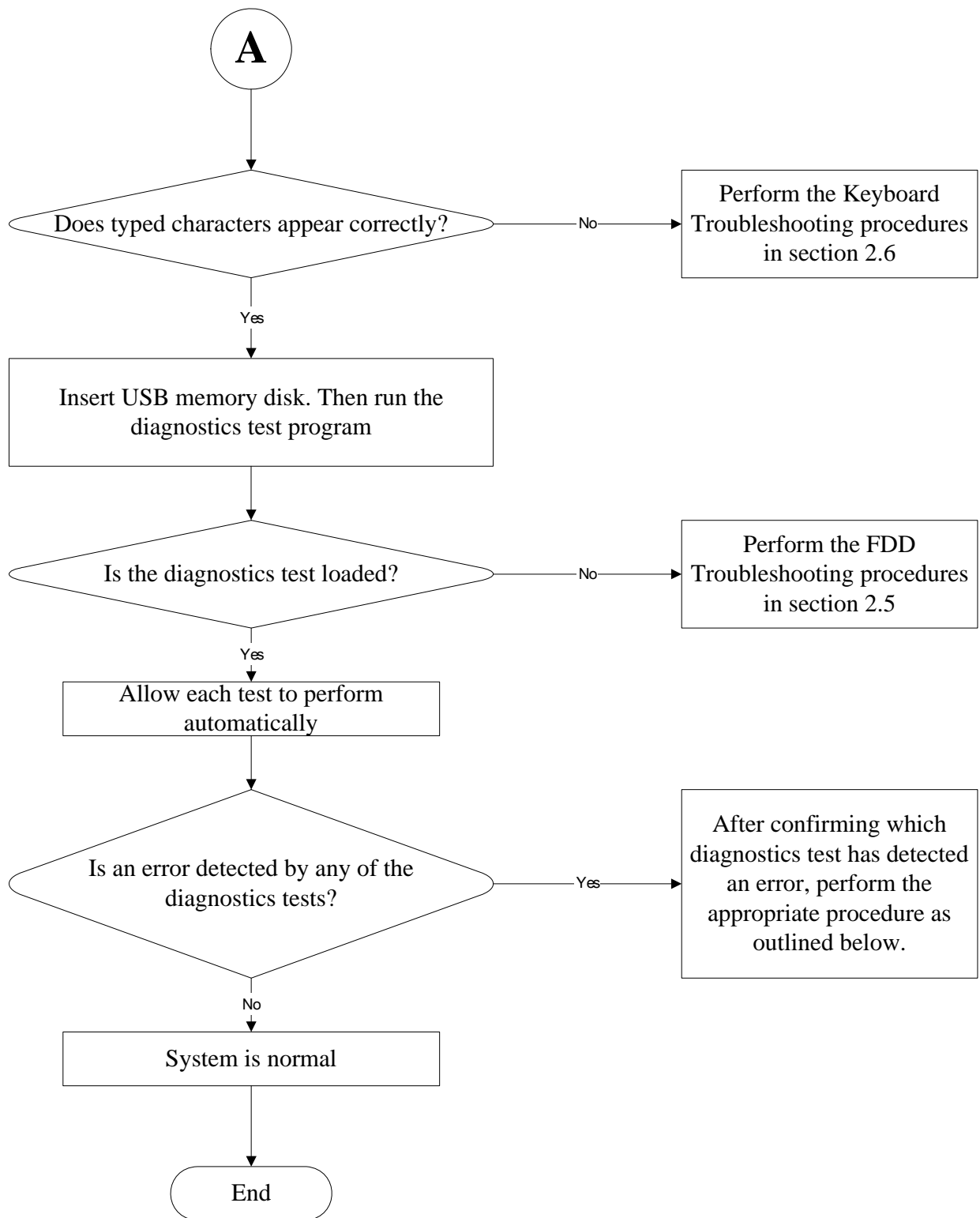

Figure 2-1 Troubleshooting flowchart (2/2)

If the diagnostics program cannot detect an error, the problem may be intermittent. The test program should be executed several times to isolate the problem. When a problem has been located, perform the appropriate troubleshooting procedures as follows:

1. If an error is detected by the battery test, perform the Power Supply Troubleshooting procedures in Section 2.3
2. If an error is detected by the display test, perform the Display Troubleshooting procedures in Section 2.4
3. If an error is detected by the keyboard test, perform the Keyboard Troubleshooting procedures in Section 2.5
4. If an error is detected by the TouchPad test, perform the TouchPad Troubleshooting procedures in Section 2.7
5. If an error is detected by the audio test, perform the Speaker Troubleshooting procedures in Section 2.8 and the Optical Drive Troubleshooting Procedures in Section 2.9

Other problems that are not covered by the diagnostics program may be discovered by a user.

1. If an error is detected when using an external USB device, perform the External USB Devices Troubleshooting procedures in Section 2.6
2. If an error is detected when using the speakers, perform the Speaker Troubleshooting procedures in Section 2.8
3. If an error is detected when using the Wireless LAN, perform the Wireless LAN Troubleshooting procedures in Section 2.10
4. If an error is detected when using the Bluetooth, perform the Bluetooth Troubleshooting procedures in Section 2.12
5. If an error is detected when using the MIC, perform the MIC troubleshooting procedures in Section 2.16

2.3 Power Supply Troubleshooting

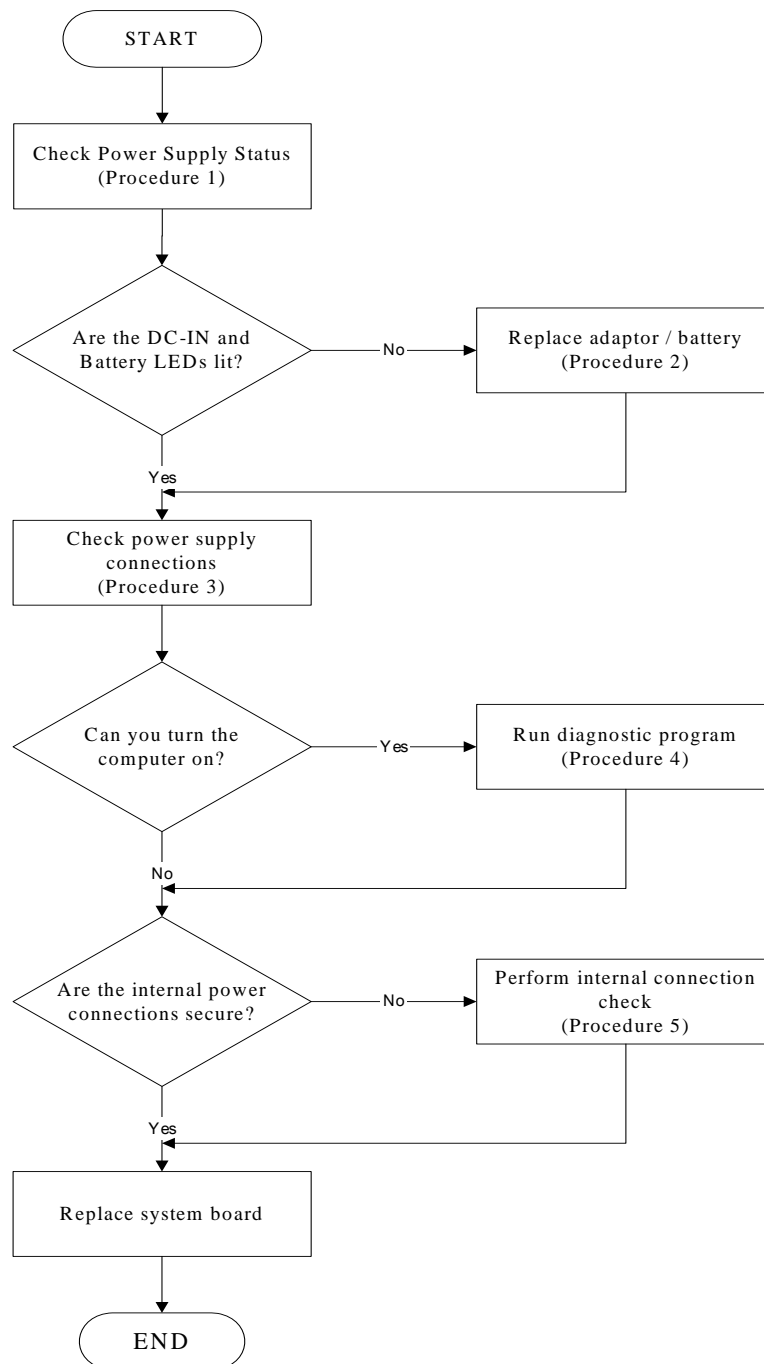

Figure 2-2 Power Supply Troubleshooting Process

The power supply controls many functions and components. To determine if the power supply is functioning properly, start with Procedure 1 and continue with the other Procedures

as instructed. The flowchart in Figure 2-2 gives a summary of the process. The procedures described in this section are:

- Procedure 1: Power status check
- Procedure 2: Adaptor / battery replacement
- Procedure 3: Power supply connection check
- Procedure 4: Diagnostic check
- Procedure 5: Internal connection check

Procedure 1 Power Status Check

The following LEDS indicate the power supply status:

 Battery LED

 DC-IN LED

The power supply controller displays the power supply status through the Battery and the DC-IN LEDS as listed in the tables below.

Table 2-1 Battery LED

Battery State	LED colors	Definition
Charging	Amber, solid on	Battery charging with AC.
	green, solid on	Battery fully charged by AC
	Amber color off	Battery abnormal stop charging with AC (Bad cell/ Overheated)
Discharging	Amber, blinking (LED on for 1 second every 4 seconds)	Battery within low state: 12 minutes remaining
	Amber, blinking (LED on for 1 second every 2 seconds)	Battery within critical low state: 3 minutes remaining. The system is protected and cannot be re-powered on without the AC power connected.
	Amber color off	Battery not in low or critical low state; It's in discharging state

Table 2-2 DC-IN LED

DC-IN LED	Power supply status
Solid on	AC power exists (LED is Green).
Off	No AC power exists.

To check the power supply status, install a battery pack and connect an AC adaptor to the DC-IN port on the computer and to a power supply.

If the DC-IN LED or Battery LED is not lit, go to Procedure 2.

Procedure 2 Adaptor / battery replacement

A faulty adaptor may not supply power or may not charge the battery. Perform Check 1.

Check 1 Connect a new AC adaptor. If the problem is not resolved, go to Check 2.

Check 2 Insert a new battery. If the problem is still not resolved, go to Procedure 3.

Procedure 3 Power supply connection check

The power supply wiring diagram is shown below:

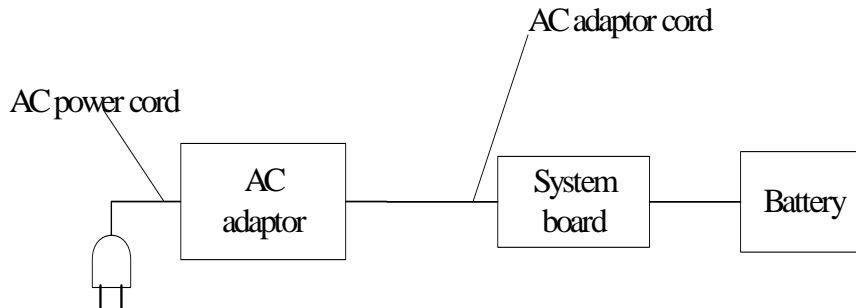

Any of the connectors may be disconnected. Perform Check 1.

- Check 1 Disconnect the AC power cord from wall outlet. Check the power cable for breaks. If the power cord is damaged, connect a new AC power cord. If there is no damage, go to Check 2.
- Check 2 Make sure the AC adaptor cord and AC power cord are firmly plugged into the DC-IN socket, AC adaptor inlet and wall outlet. If these cables are connected correctly, go to Check 3.
- Check 3 Make sure that the DC-IN input port socket is firmly secured to the system board of the computer.
- If the DC-IN input socket is loose, go to Procedure 5.
 - If it is not loose, go to Check 4.
- Check 4 Use a multi-meter to make sure that the AC adaptor output voltage is close to 19 V. If the output is several percent lower than 19 V, go to Check 5. If the output is close to 19 V, go to Check 6.
- Check 5 Connect a new AC adaptor or AC power cord.
- If the DC-IN LED does not light, go to Procedure 4.
 - If the battery LED does not light, go to Check 6.
- Check 6 Make sure the battery pack is installed in the computer correctly. If the battery is properly installed and the battery LED still does not light, go to Procedure 4.

Procedure 4 Diagnostic check

The power supply may not charge the battery pack. Perform the following procedures:

1. Reinstall the battery pack.
2. Attach the AC adaptor and turn on the power. If you cannot turn on the power, go to Procedure 5.
3. Run the Diagnostic test following the procedures described in Chapter 3, Tests and Diagnostics. If no problem is detected, the battery is functioning normally.

Procedure 5 Replacement check

The system board may be disconnected or damaged. Disassemble the computer following the steps described in Chapter 4, *Replacement Procedures*. Check the connection between the AC adaptor and the system board. After checking the connection, perform Check 1:

- Check 1 Use a multi-meter to make sure that the fuses on the system board are not blown. If a fuse is not blown, go to Check 2. If a fuse is blown, go to Check 3.
- Check 2 Make sure that the battery cable is firmly connected to the system board. If it is connected firmly, go to Check 3.
- Check 3 The system board may be damaged. Replace it with a new one following the instructions in Chapter 4.

2.4 Display Troubleshooting

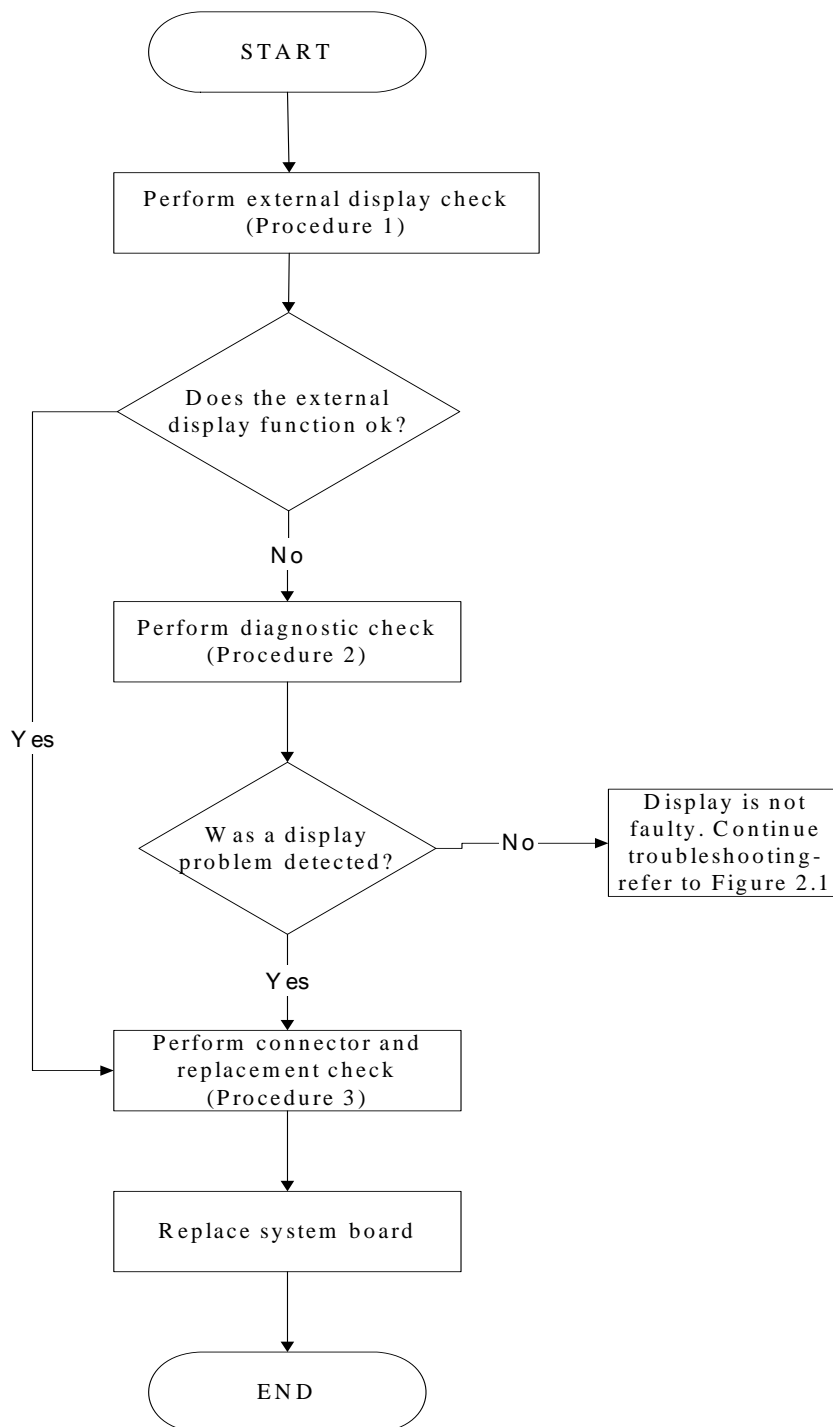

Figure 2-3 Display troubleshooting process

This section describes how to determine if the computer's display is functioning properly. The process is outlined in Figure 2-3. Start with Procedure 1 and continue with the other procedures as instructed.

Procedure 1: External display check

Procedure 2: Diagnostic check

Procedure 3: Connector and replacement check

Procedure 1 External display check

Connect an external display to the computer's external monitor port, and then boot the computer. The computer automatically detects the external display.

If the external display works correctly, the internal LCD may be damaged. Go to Procedure 3.

If the external monitor appears to have the same problem as the internal monitor, the system board may be damaged. Go to Procedure 2.

Procedure 2 Diagnostic check

The Display Test program is stored on the computer's Diagnostics disk. This program checks the display controller on the system board. Insert the Diagnostics disk in the computer's floppy disk drive, turn on the computer and run the test. Refer to Chapter 3, *Tests and Diagnostics* for details.

If an error is detected, go to Procedure 3. If an error is not detected, the display is functioning properly.

Procedure 3 Connector and replacement check

The LCD module and system board are connected to the display circuits. Any of these components may be damaged. Refer to Chapter 4, *Replacement Procedures*, for instructions on how to disassemble the computer and then perform the following checks:

- Check 1 Make sure the DDR module is seated properly. Test display again. If the problem still exists, replace the DDR RAM module. If the problem still exists, perform Check 2.
- Check 2 Replace the LCD module with a new one and test display again. If the problem still exists, perform Check 4.
- Check 3 Replace the LCD cable with a new one and test display again. If the problem still exists, perform Check 5.
- Check 4 The system board may be damaged. Replace it with a new one.

2.5 Keyboard Troubleshooting

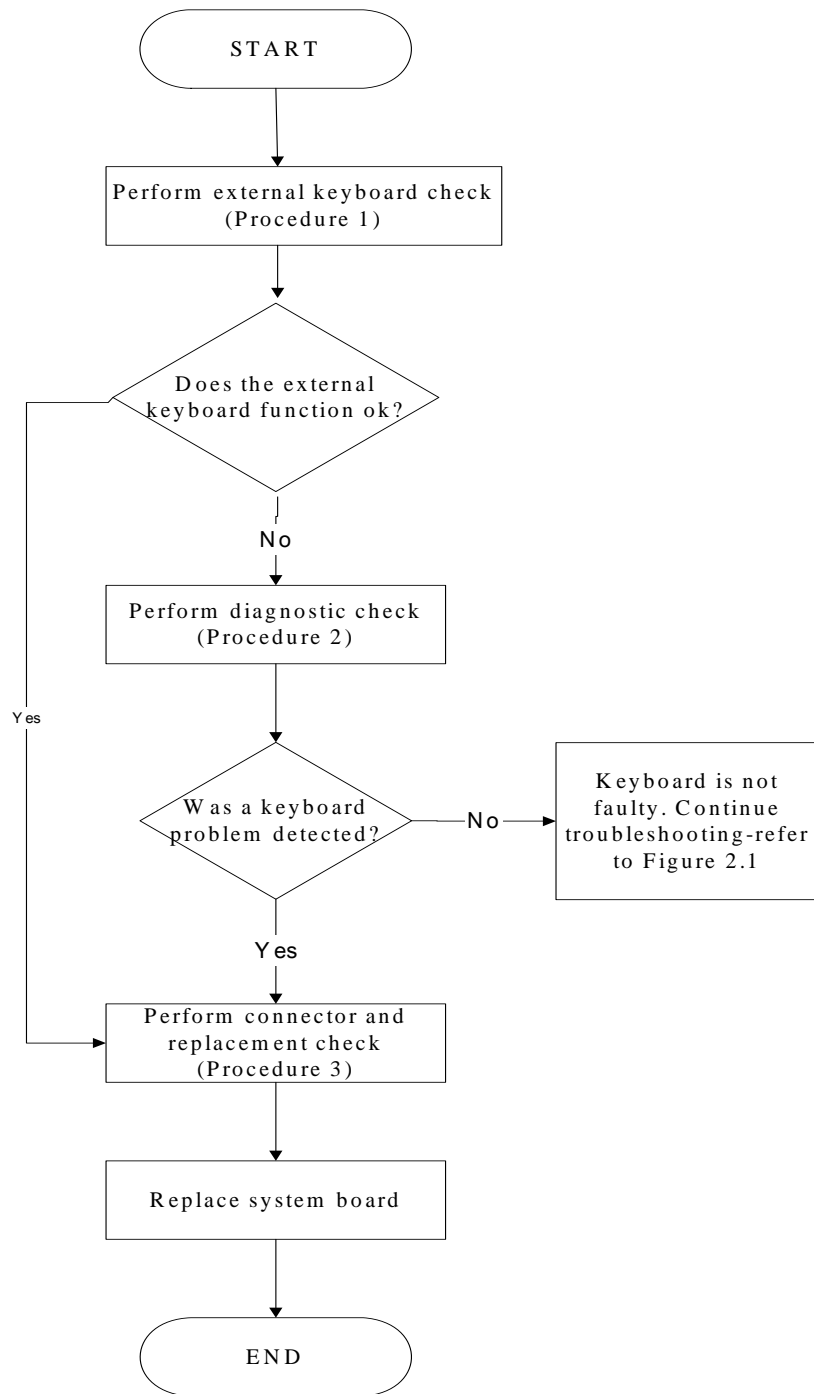

Figure 2-4 Keyboard troubleshooting process

To determine if the computer's keyboard is functioning properly, perform the following procedures. Figure 2-5 outlines the process. Start with Procedure 1 and continue with the other procedures as instructed.

Procedure 1: External keyboard check

Procedure 2: Diagnostic check

Procedure 3: Connector and replacement check

Procedure 1 External keyboard check

Connect a USB keyboard to one of the computer's USB ports, and then boot the computer. The computer automatically detects the external keyboard.

If the external keyboard works correctly, the internal keyboard or its connections may be faulty. Go to Procedure 2.

If the external keyboard appears to have the same problem as the internal keyboard, the system board may be having some problem. Replace it with a new one and following the instructions in Chapter 4.

Procedure 2 Diagnostic check

Run the test and Diagnostics Program, which will automatically execute the Keyboard Test. Refer to Chapter 3, *Tests and Diagnostics* for more information on how to run the program.

If an error is located, go to Procedure 3. If an error does not occur, the keyboard is functioning ok.

Procedure 3 Connector and replacement check

The keyboard and/or system board may be disconnected or damaged. Disassemble the computer following the steps described in Chapter 4, *Replacement Procedures* and perform the following checks.

Check 1 Make sure the keyboard cable is firmly connected to the system board.

If the connection is loose, reconnect firmly and repeat Procedure 2. If there is still an error, go to Check 2.

Check 2 The keyboard may be damaged. Replace it with a new one following the instructions in Chapter 4.

If the problem still exists, perform Check 3.

Check 3 The system board may be damaged. Replace it with a new one following the instructions in Chapter 4.

2.6 External USB Devices Troubleshooting

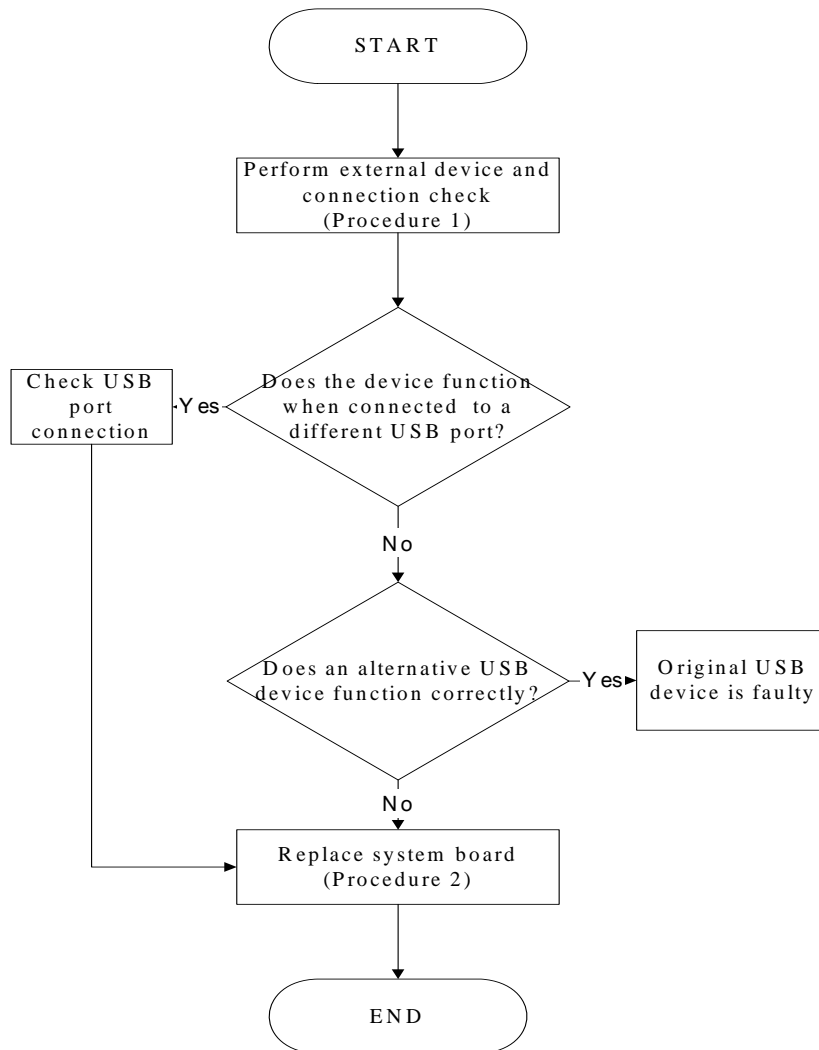

Figure 2-5 External USB device troubleshooting process

To determine if the computer's external USB devices are functioning properly, perform the following procedures. Figure 2-6 outlines the process. Start with Procedure 1 and continue as instructed.

Procedure 1: External device and connection check

Procedure 2: Replace system board

Procedure 1 External device and connection check

The USB device may be damaged or the connection may be faulty. Perform Check 1.

Check 1 Make sure USB device cable is firmly plugged into one of the USB sockets. If the cable is connected correctly, go to Check 2.

Check 2 Plug the USB device into another USB socket (there are three in all). If the USB device still does not work, go to Check 4.

If the device functions correctly when connected to another USB port, go to Check 3.

Check 3 Make sure that the USB socket is firmly secured to the system board of the computer. If the malfunction remains, the system board or USB small board may be damaged. Go to Procedure 2.

Check 4 Connect an alternative USB device to one of the computer's USB ports, and then boot the computer. The computer automatically detects the external device.

If the alternative USB device works correctly, the original device may be damaged and should be replaced.

If the alternative USB device appears to have the same problem as the original device, the system board or USB small board may be damaged. Go to Procedure 2.

Procedure 2 Replace system board

If the error persists, the system board or USB small board may be damaged. Replace it with a new one following the instructions in Chapter 4.

2.7 TouchPad Troubleshooting

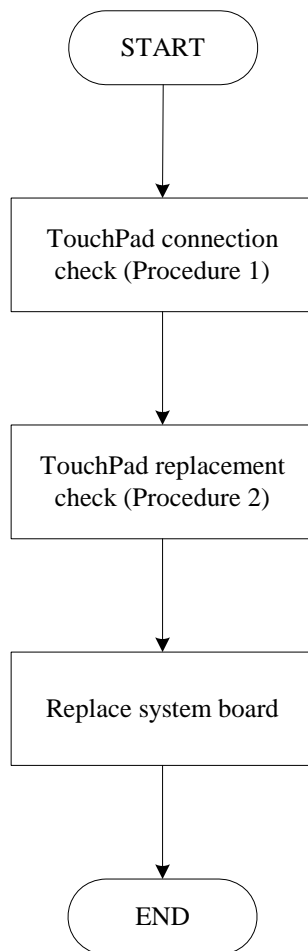

Figure 2-6 Touchpad troubleshooting process

To determine if the computer's built-in TouchPad is functioning properly, perform the following procedures. Figure 2-9 outlines the process. Start with Procedure 1 and continue as instructed.

Procedure 1: TouchPad connection check

Procedure 2: TouchPad replacement check

Procedure 1 TouchPad connection check

The TouchPad is connected via the TouchPad FPC to the system board. Make sure the TouchPad FPC cable is firmly connected to the TouchPad and system board. Refer to Chapter 4, *Replacement Procedures*, for instructions on how to disassemble the computer and then perform the following checks.

If any of the connections are loose, reconnect firmly. If any of the connections is damaged, or there is still an error, go to Procedure 2.

Procedure 2 TouchPad replacement check

The TouchPad unit or FPC may be defective or damaged. Replace each with a new one following the steps in Chapter 4. If the FDD is still not functioning properly, replace the system board with a new one following the steps in Chapter 4.

2.8 Speaker Troubleshooting

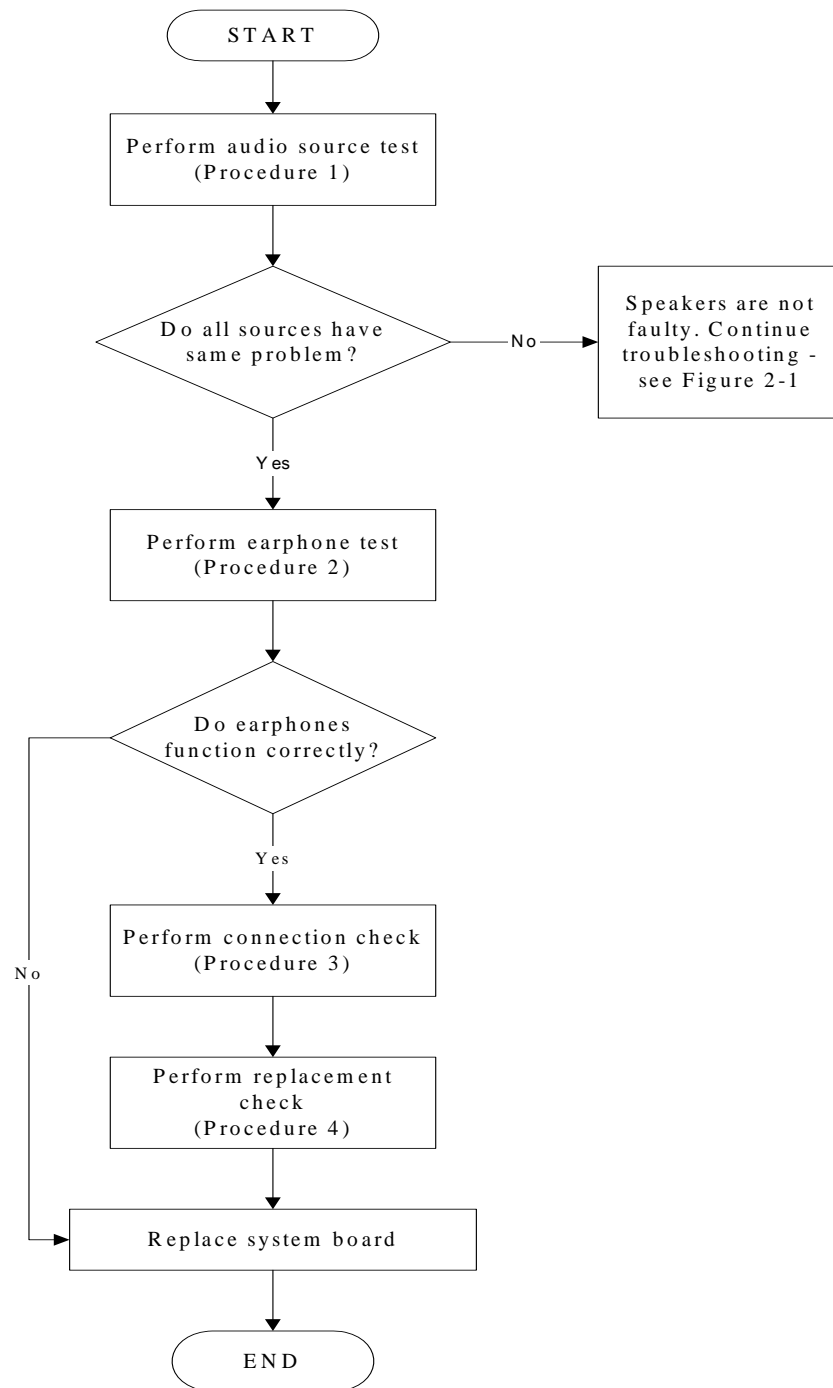

Figure 2-7 Speaker troubleshooting process

To determine if the computer's built-in speakers are functioning properly, perform the following procedures. Figure 2-10 outlines the process. First adjust the speaker volume to an appropriate level. Start with Procedure 1 and continue as instructed.

Procedure 1: Audio source test

Procedure 2: Earphone test

Procedure 3: Connection check

Procedure 4: Replacement check

Procedure 1 Audio source test

Try different audio sources (e.g. an audio CD and digital music file) to determine whether the fault is in the speaker system or not. If not all sources have sound problem, the problem is in the monaural devices. If all have the same problem, continue with Procedure 2.

Procedure 2 Earphone test

Connect a set of earphones or external speakers. If these function correctly, go to Procedure 3. If they do not function correctly, the system board may be defective or damaged. Replace it with a new one.

Procedure 3 Connection check

Disassemble the computer following the steps described in Chapter 4, *Replacement Procedures* and make sure the speaker cable is firmly connected to the audio board. If the speakers are still not functioning properly, go to Procedure 4.

Procedure 4 Replacement check

If the stereo speakers don't sound properly, the stereo speakers may be defective or damaged. Replace them with new ones. If the stereo speakers still do not work properly, try replacing in turn the audio board and system board.

2.9 Wireless LAN Troubleshooting

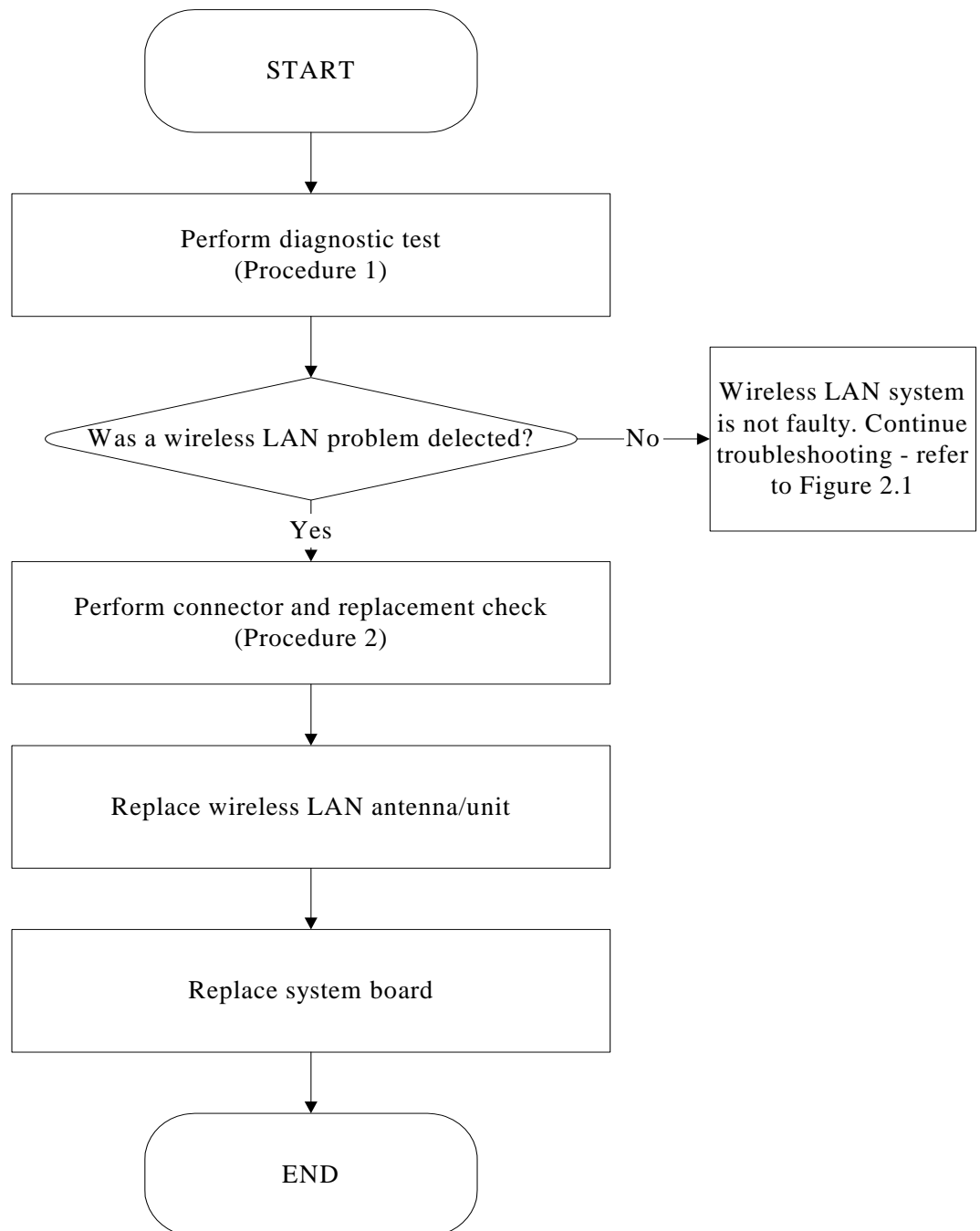

Figure 2-8 Wireless LAN troubleshooting process

The wireless LAN antenna wire, wireless LAN unit or system board may each be the source of a wireless LAN fault. Any of these components may be damaged. To determine if the computer's wireless LAN system is functioning properly, perform the following procedures.

Figure 2-15 outlines the process. Start with Procedure 1 and continue with the other procedures as instructed.

Procedure 1: Diagnostic test

Procedure 2: Connector and replacement check

Procedure 1 Diagnostic test

Run the Diagnostic Program, which will automatically execute the wireless LAN test. Refer to Chapter 3 item A: CONFIG CHECK TEST” Test and Diagnostic for more information on the program.

If an error is located, go to Procedure 2. If an error is not located, the wireless LAN system is functioning properly.

Procedure 2 Connector and replacement check

The wireless LAN antenna, wireless LAN unit or system board may be disconnected or damaged. Disassemble the computer following the steps described in Chapter 4, *Replacement Procedures*, and perform the following checks.

- Check 1 Make sure that the wireless LAN antenna is firmly connected to the Wireless LAN module (refer to Chapter 4 for instructions) and that the wireless LAN module is securely slotted into the system board. If the problem persists, go to Check 2.
- Check 2 Check that the wireless communication function is enable by BIOS setup or FN+F8 , and then make sure that the wireless communication LED on the front panel is light. If the LED is light but the wireless LAN function is still faulty, the antenna may be damaged. Replace with a new antenna following the steps in Chapter 4, *Replacement Procedures*. If the problem persists, or if the wireless LAN LED is not light when the wireless communication function is enabled by BIOS setup or FN+F8, go to Check 3.
- Check 3 The wireless LAN unit may be damaged. Replace it with a new one following the instructions in Chapter 4. If the problem still exists, perform Check 4.
- Check 4 The system board may be damaged. Replace it with a new one following the instructions in Chapter 4.

2.10 Camera Troubleshooting

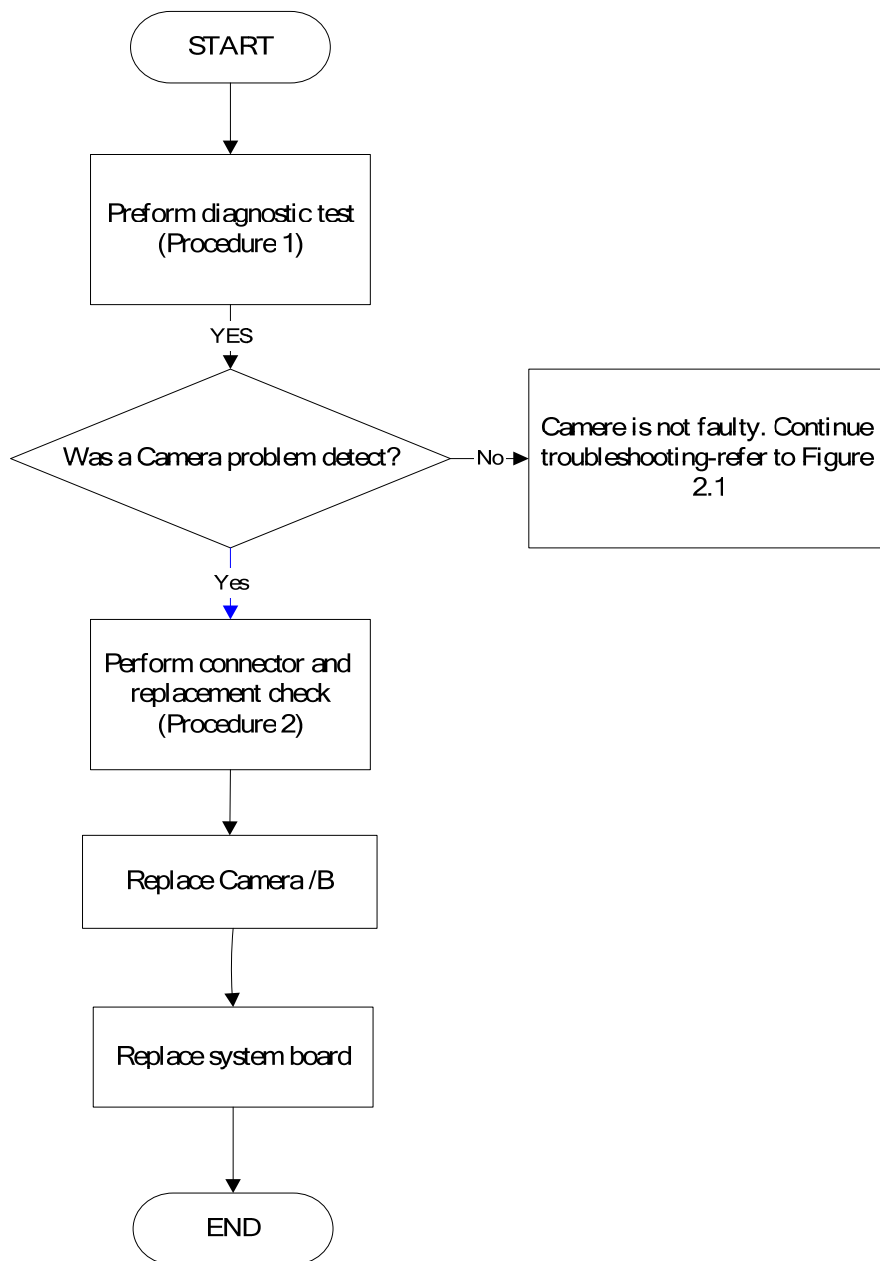

Figure 2-9 Camera troubleshooting process

The Camera board or system board may be the reason of a Camera fault. Either of these two components may be damaged. To determine if the computer's Camera is functioning properly, perform the following procedures. Figure 2-14 outlines the process. Start with Procedure 1 and continue with the other procedures as instructed.

Procedure 1: Diagnostic test

Procedure 2: Connector and replacement check

Procedure 1 Diagnostic test

Run the functioning Program in windows, which will display the Camera test result.

If tests and diagnostics result abnormal go to Procedure 2. If an error is not located, the Camera system is functioning properly.

Procedure 2 Connector and replacement check

The Camera board or system board may be disconnected or damaged. Disassemble the computer following the steps described in Chapter 4, *Replacement Procedures*, and perform the following checks.

- Check 1 Make sure that the Camera board cable is securely slotted into the system board. If the problem persists, go to Check 2.
- Check 2 The Camera board may be damaged. Replace it with a new one following the instructions in Chapter 4. If the problem still exists, perform Check 3.
- Check 3 The system board may be damaged. Replace it with a new one following the instructions in Chapter 4.

2.11 Bluetooth Troubleshooting

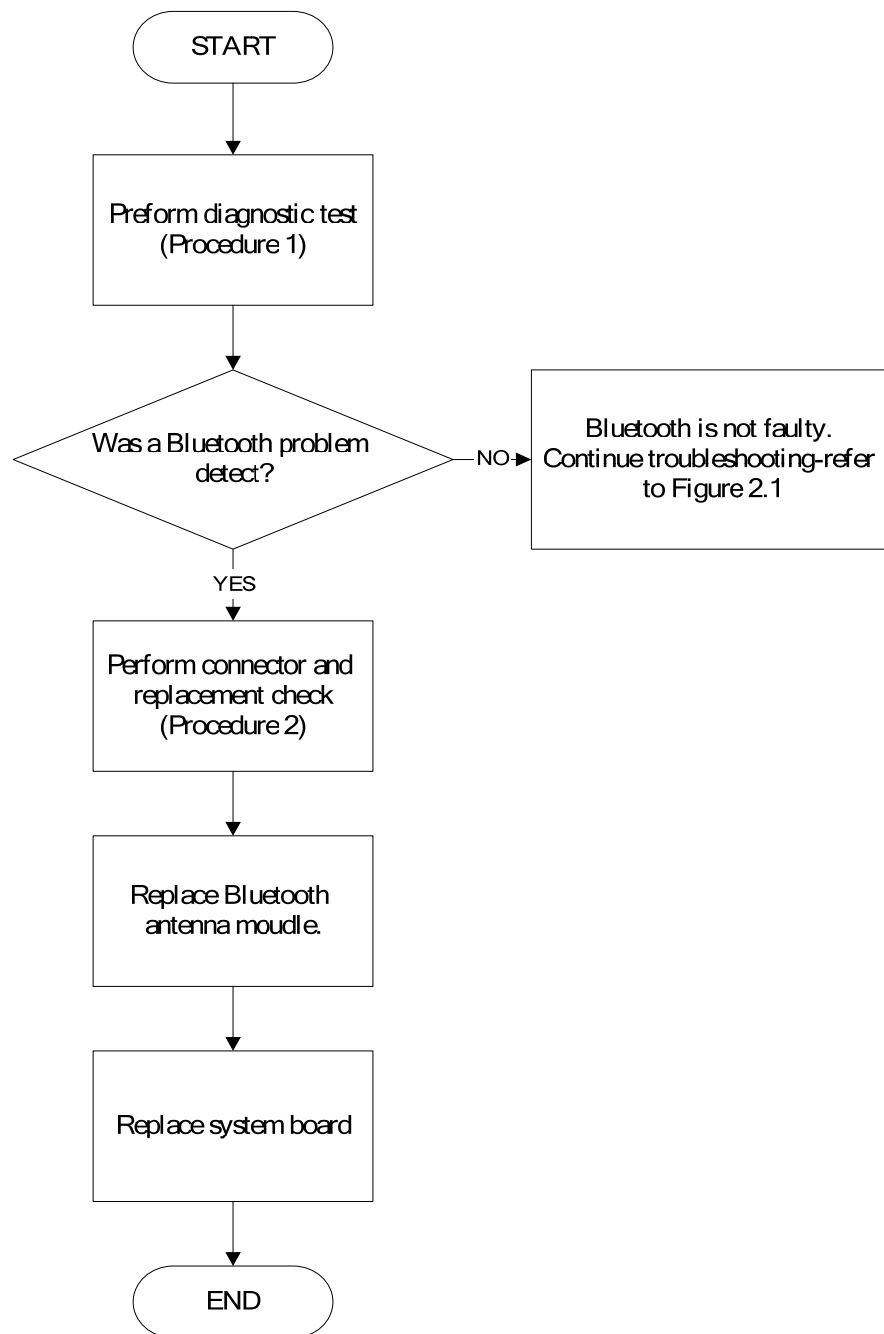

Figure 2-10 Bluetooth troubleshooting process

The Bluetooth antenna wire, Bluetooth module or system board may be the reason of a Bluetooth fault. Any of these components may be damaged. To determine if the computer's Bluetooth is functioning properly, perform the following procedures. Figure 2-16 outlines the process. Start with Procedure 1 and continue with the other procedures as instructed.

Procedure 1: Diagnostic test

Procedure 2: Connector and replacement check

Procedure 1 Diagnostic test

Run the Diagnostic Program, which will automatically execute the Bluetooth test. Refer to Chapter 3 item A: "CONFIG CHECK TEST", Tests and Diagnostics for more information on the program.

If an error is located, go to Procedure 2. If an error is not located, the Bluetooth system is functioning properly.

Procedure 2 Connector and replacement check

The Bluetooth, antenna module or system board may be disconnected or damaged. Disassemble the computer following the steps described in Chapter 4, *Replacement Procedures*, and perform the following checks.

- Check 1 Make sure the Bluetooth cable is securely slotted into the system board. If the problem persists, go to Check 2.
- Check 2 Check the wireless communication function is enabled by BIOS setup or FN+F8, then make sure that the communication LED on the left panel is lit. If the problem persists, or if the Bluetooth communication LED is not lit when the wireless communication function is enabled by BIOS setup or FN+F8 to "On", go to Check 3.
- Check 3 The Bluetooth module may be damaged. Replace it with a new one following the instructions in Chapter 4. If the problem still exists, perform Check 4.
- Check 4 The system board may be damaged. Replace it with a new one following the instructions in Chapter 4.

2.12 3in1 card Troubleshooting

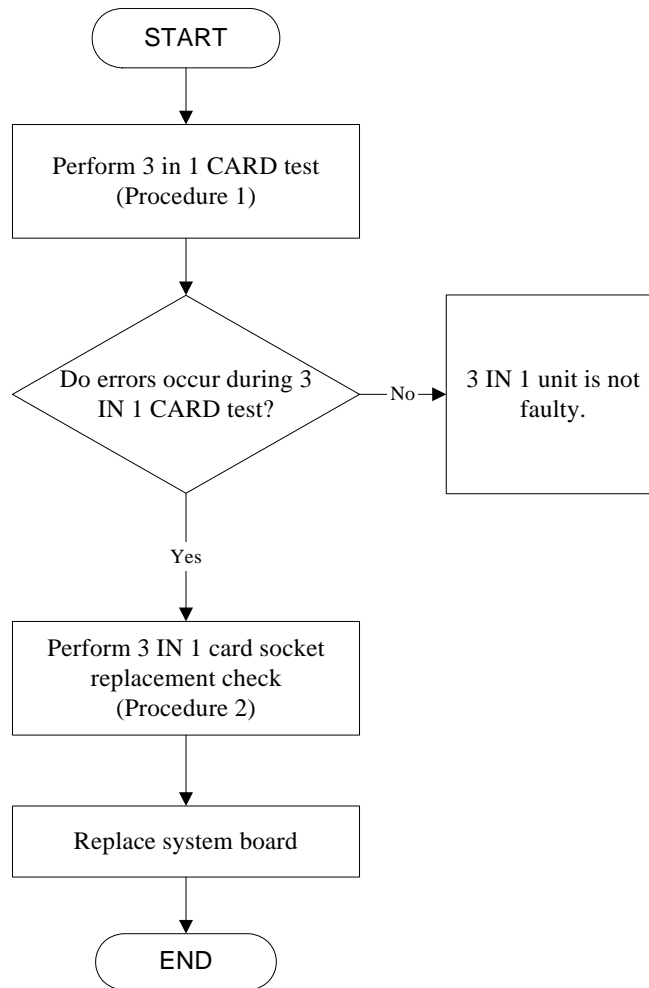

Figure 2-11 3in 1 card troubleshooting process

This section describes how to determine if the 3 IN 1 Card is functioning properly. The process is summarized in Figure 2-16. Perform the steps below starting with Procedure 1 and continuing with the other procedures as required.

Procedure 1: 3 in 1 card test

Procedure 2: 3 in 1 card socket check

Procedure 1 3 in 1 card test

The 2 in 1 Card test card contains a 3 in 1 card test program. Ensure the card is fully inserted into the socket before running the program.

If an error occurs during the 3 in 1 card test, perform Procedure 2. If no error occurs, it is likely that the original 3 in 1 card was faulty.

Procedure 2 3 in 1 Card socket check

The 3 in 1 Card socket may be damaged or defective, for instance the socket pins can be bent. Disassemble the computer following the steps described in Chapter 4, Replacement Procedures and check the socket. If the problem persists, the system board may be defective or damaged. Replace the system board with a new one following the steps in Chapter 4.

2.13 HDD/SSD Troubleshooting

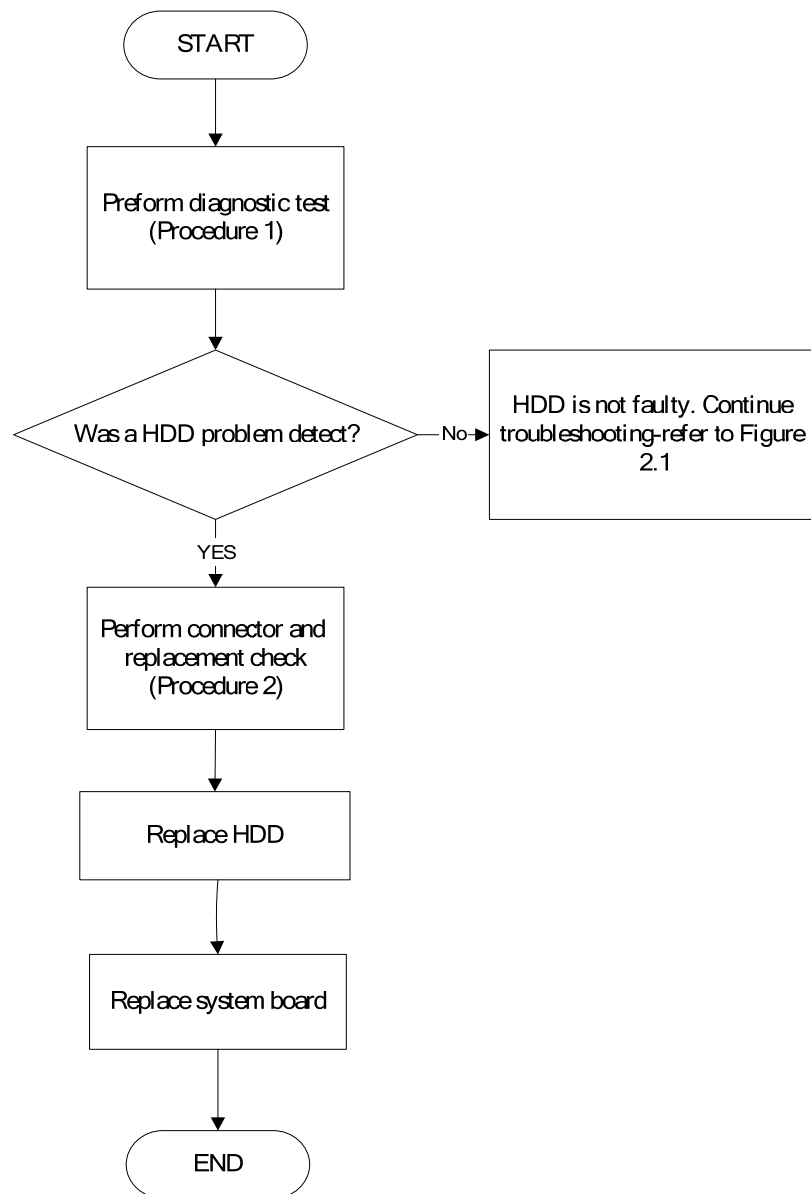

Figure 2-12 HDD troubleshooting process

The HDD or system board may be the reason of a HDD fault. Either of these two components may be damaged. To determine if the computer's HDD is functioning properly, perform the following procedures. Figure 2-15 outlines the process. Start with Procedure 1 and continue with the other procedures as instructed.

Procedure 1: Diagnostic test

Procedure 2: Connector and replacement check

Procedure 1 Diagnostic test

Run the Diagnostic Program, which will automatically execute the HDD R/W test. Refer to Chapter 3, Tests and Diagnostics for more information on the program.

If an error is located, go to Procedure 2. If an error is not located, the HDD function is functioning properly.

Procedure 2 Connector and replacement check

The HDD module or system board may be disconnected or damaged. Disassemble the computer following the steps described in Chapter 4, *Replacement Procedures*, and perform the following checks.

- Check 1 Make sure that the HDD module is securely slotted into the system board. If the problem persists, go to Check 2.
- Check 2 The HDD module may be damaged. Replace it with a new one following the instructions in Chapter 4. If the problem still exists, perform Check 3.
- Check 3 The system board may be damaged. Replace it with a new one following the instructions in Chapter 4.

2.14 CRT Troubleshooting

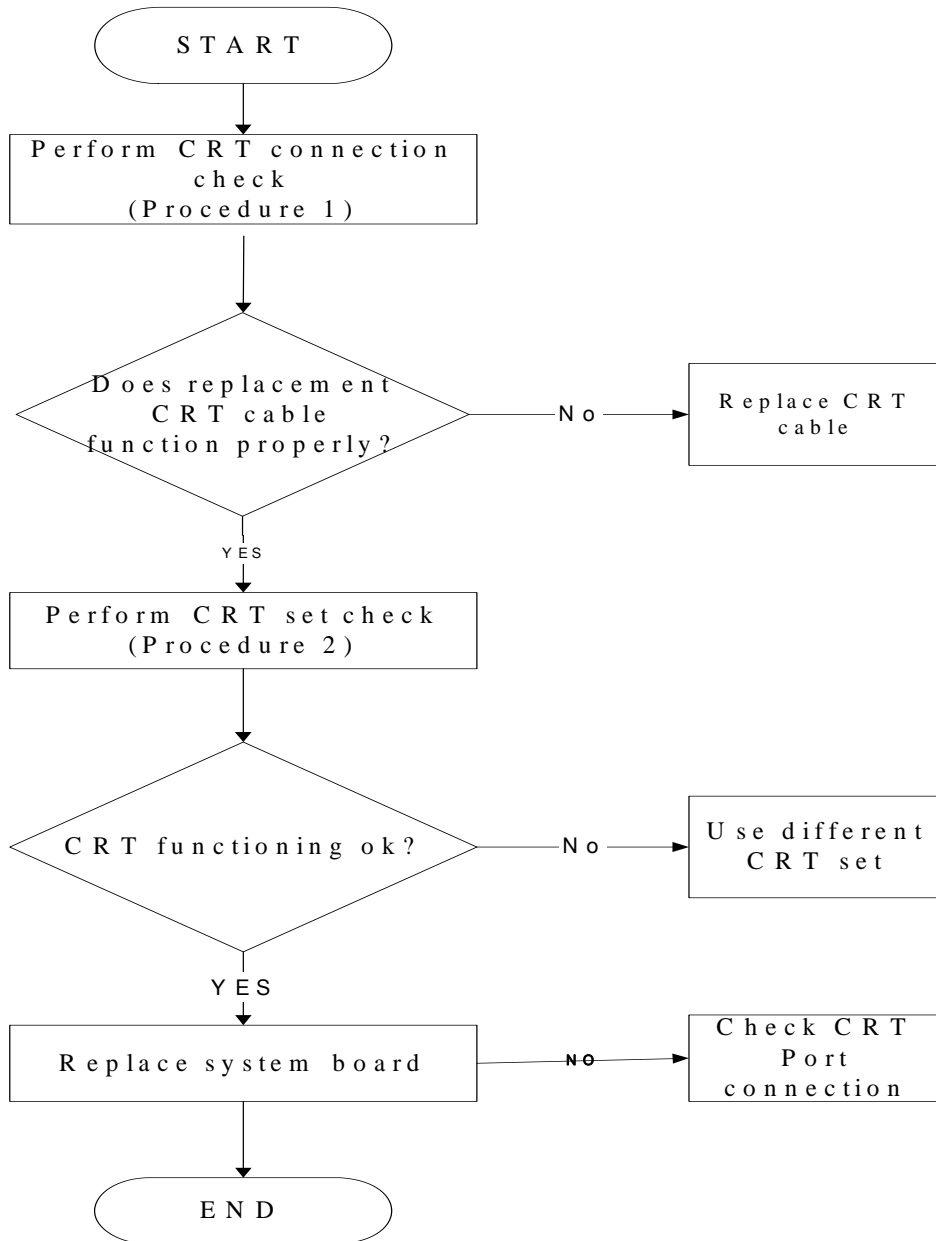

Figure 2-13 CRT troubleshooting process

To determine if the computer's CRT port is functioning properly, perform the following procedures. Figure 2-7 outlines the process. Start with Procedure 1 and continue as instructed.

Procedure 1: CRT connection check

Procedure 2: CRT set check

Procedure 1 CRT connection check

The CRT cable may be damaged or the connections may be loose. Perform Check 1:

- Check 1 Make sure CRT cable is firmly plugged into both the CRT set and the CRT port of the computer. If the cable is connected correctly, go to Check 2.
- Check 2 Make sure the CRT port is firmly secured to the system board of the computer. If the malfunction remains, go to Check 3.
- Check 3 The CRT cable may be damaged. Replace with a good cable. If the malfunction remains, go to Procedure 2.

Procedure 2 CRT set check

The CRT set may be faulty. Perform Check 1:

- Check 1 Try using the set for CRT reception. If it does not work, the set may be damaged. If the set does work, perform Check 2.
- Check 2 Try connecting a different CRT to the computer. If the replacement CRT works, the original set may be damaged. If the replacement set does not work the system board may be damaged. Replace it with a new one following the instructions in Chapter 4.

2.15 LAN Troubleshooting

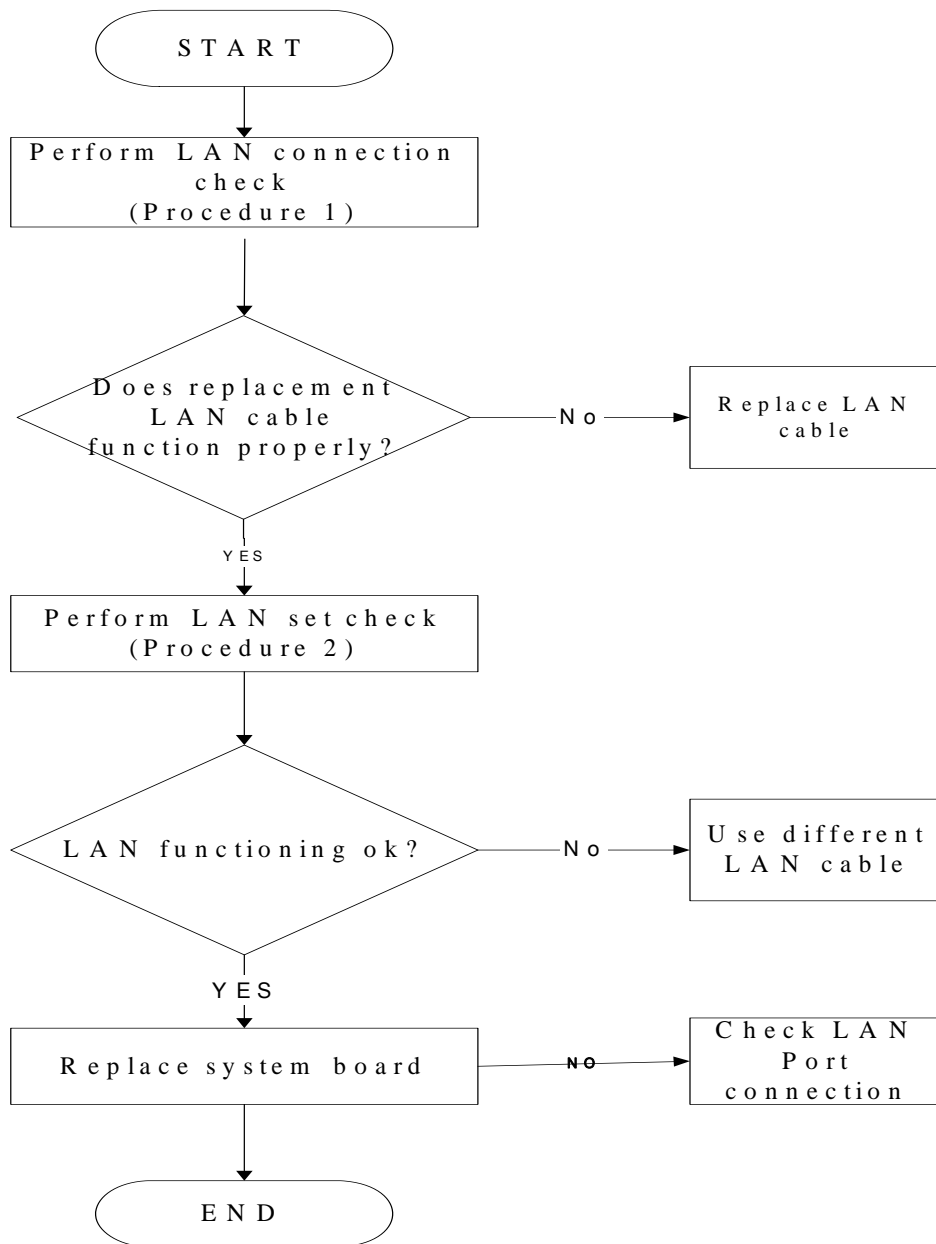

Figure 2-14 LAN troubleshooting process

To determine if the computer's LAN port is functioning properly, perform the following procedures. Figure 2-7 outlines the process. Start with Procedure 1 and continue as instructed.

Procedure 1: LAN Diagnostic test

Procedure 2: LAN connection check

Procedure 3: LAN set check

Procedure 1 LAN Diagnostic test

Run the Diagnostic Program, which will automatically execute the LAN test. Refer to Chapter 3 item K: “LAN TEST”, Tests and Diagnostics for more information on the program.

If an error is located, go to Procedure 2. If an error is not located, the Bluetooth system is functioning properly.

Procedure 2 LAN connection check

The LAN cable may be damaged or the connections may be loose. Perform Check 1:

Check 1 Make sure LAN cable is firmly plugged into both the LAN set and the LAN port of the computer. If the cable is connected correctly, go to Check 2.

Check 2 Make sure the LAN port is firmly secured to the system board of the computer. If the malfunction remains, go to Check 3.

Check 3 The LAN cable may be damaged. Replace with a good cable. If the malfunction remains, go to Procedure 2.

Procedure 3 LAN set check

The LAN set may be faulty. Perform Check 1:

Check 1 Try using the set for LAN reception. If it does not work, the set may be damaged. If the set does work, perform Check 2.

Check 2 Try connecting a different LAN cable to the computer. If the replacement LAN cable works, the original set may be damaged. If the replacement set does not work the system board may be damaged. Replace it with a new one following the instructions in Chapter 4.

2.16 MIC Troubleshooting

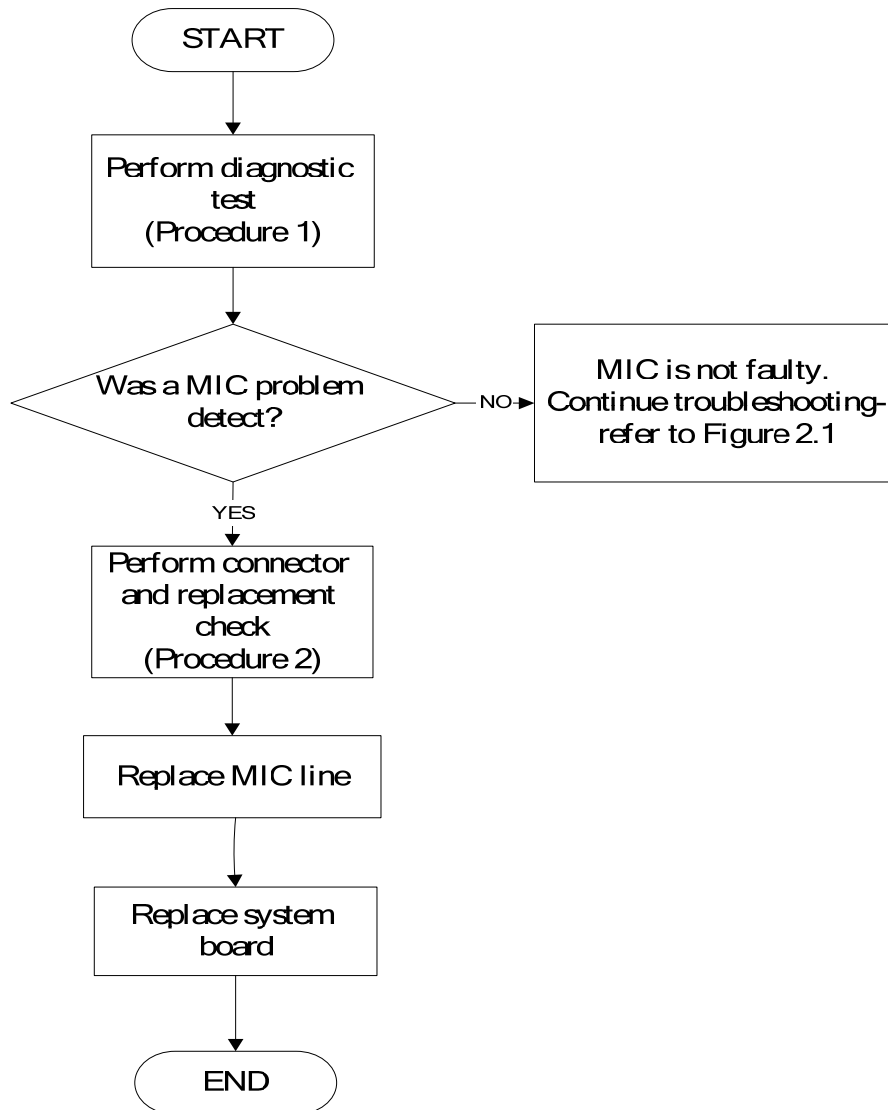

Figure 2.15. MIC troubleshooting process

The MIC line or system board may be the reason of a MIC fault. Either of these two components may be damaged. To determine if the computer's MIC is functioning properly, perform the following procedures. Figure 2-15 outlines the process. Start with Procedure 1 and continue with the other procedures as instructed.

Procedure 1: Diagnostic test

Procedure 2: Connector and replacement check

Procedure 1 Diagnostic test

Run the functioning Program on Windows model, which will display the MIC test result.

If tests and diagnostics result abnormal go to Procedure 2. If an error is not located, the MIC module functioning is properly.

Procedure 2 Connector and replacement check

The MIC line or system board may be disconnected or damaged. Disassemble the computer following the steps described in Chapter 4, *Replacement Procedures*, and perform the following checks.

- Check 1 Make sure that the MIC line is securely slotted into the system board. If the problem remains, go to Check 2.
- Check 2 The MIC line may be damaged. Replace it with a new one following the instructions in Chapter 4. If the problem still exists, perform Check 3.
- Check 3 The system board may be damaged. Replace it with a new one following the instructions in Chapter 4.

2.17 Button Troubleshooting

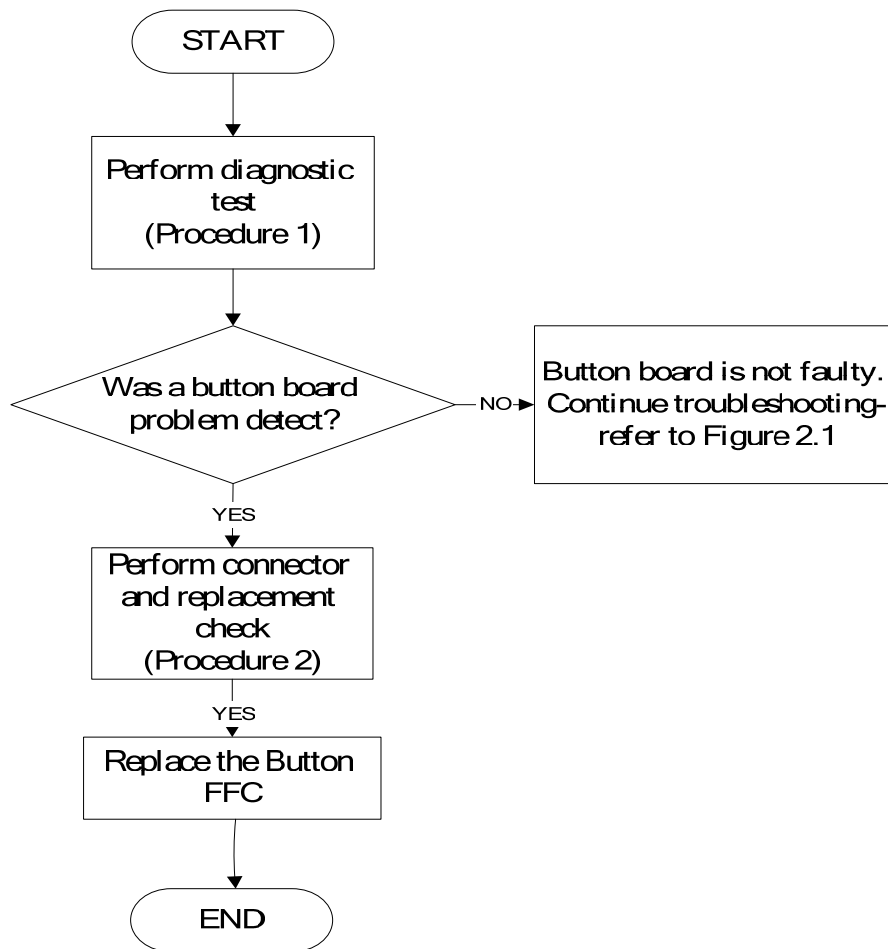

Figure 2.16. Button troubleshooting process

The small board of button or the FFC assemblies maybe the reason of button function fault. Either of these two may be damaged. To determine if the computer's button is functioning properly, perform the following procedures. Figure 2-16 outlines the process. Start with Procedure 1 and continue with the other procedures as instructed.

Procedure 1: Diagnostic test

Procedure 2: Replacement check

Procedure 1 Diagnostic test

Run the functioning Program on Windows model or DOS model, which will display the test result.

If tests and diagnostics result abnormal go to Procedure 2. If an error is not located, the button functioning is properly.

Procedure 2 Replacement check

Disassemble the computer following the steps described in Chapter 4, *Replacement Procedures*, and perform the following checks.

- Check 1 Make sure that Button test operation is correct, go to Check 2.
- Check 2 Make sure that the FFC of the button is assemble OK, go to Check 3
- Check 3 The button may be damaged. Replace it with a new one following the instructions in Chapter 4.

2.18 modem Troubleshooting

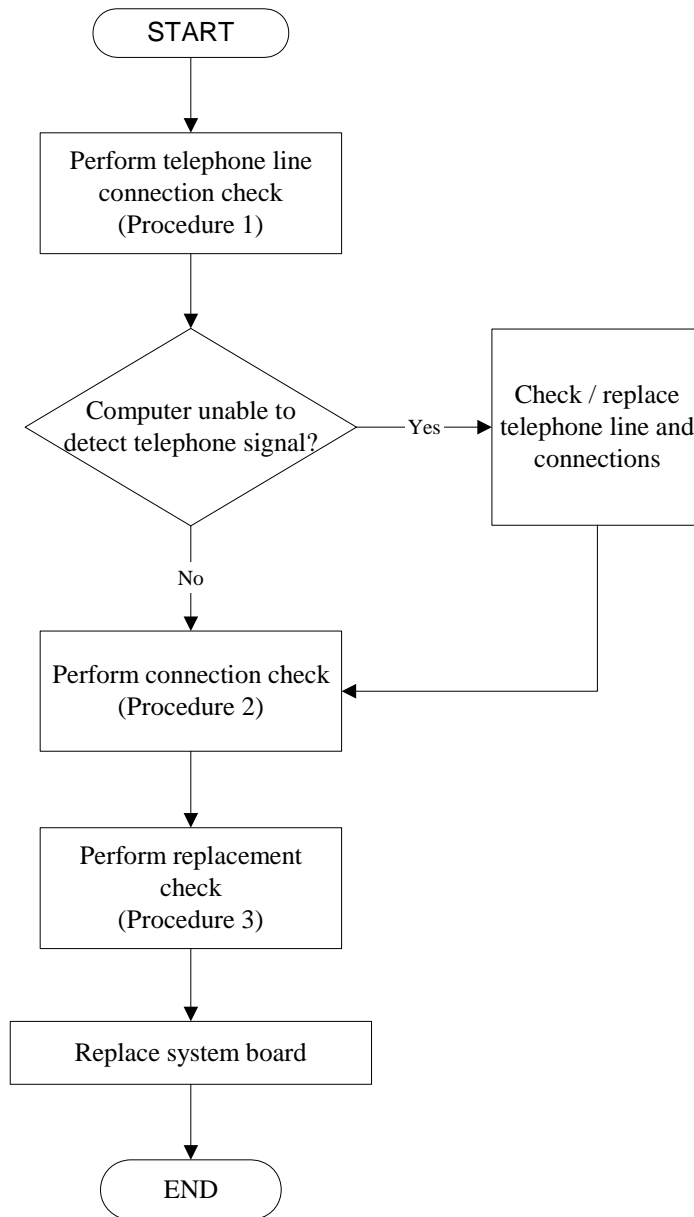

Figure 2-17 Modem troubleshooting process

This section describes how to determine if the computer's modem is functioning properly. Figure 2-12 outlines the process. Perform the steps below starting with Procedure 1 and continuing with the other procedures as required.

Procedure 1: Telephone line connection check

Procedure 2: Modem card connection check

Procedure 3: Modem card replacement check

Procedure 1 Telephone line connection check

The telephone cable may be damaged or the connections may be loose. Use windows application to check device can work fine or not. Attempt to connect the computer to a network through using the modem. If the modem does not function at all, go to Procedure 3. If the attempt fails because the computer detects no telephone signal, the fault may be in the telephone cable, the wall socket or the modem port. Perform Check 1:

- Check 1 Make sure telephone cable is firmly plugged into both the telephone wall socket and the modem port of the computer. If the cable is connected correctly, go to Check 2.
- Check 2 Make sure the modem port is firmly secured to the system board of the computer. If the malfunction remains, go to Check 3.
- Check 3 The telephone cable may be damaged. Replace with a good cable. If the malfunction remains, go to Procedure 2.

Procedure 2 Modem card connection check

Disassemble the computer following the steps described in Chapter 4, *Replacement Procedures* and ensure that the modem card is well connected to the system board. If the problem persists, perform Procedure 3.

Procedure 3 Modem replacement check

The modem card or RJ-11 jack may be faulty. Try replacing them. If the problem persists, the system board may be defective or damaged. Replace the System Board with a new one following the steps in Chapter 4, *Replacement Procedures*.

2.19 Express card Troubleshooting

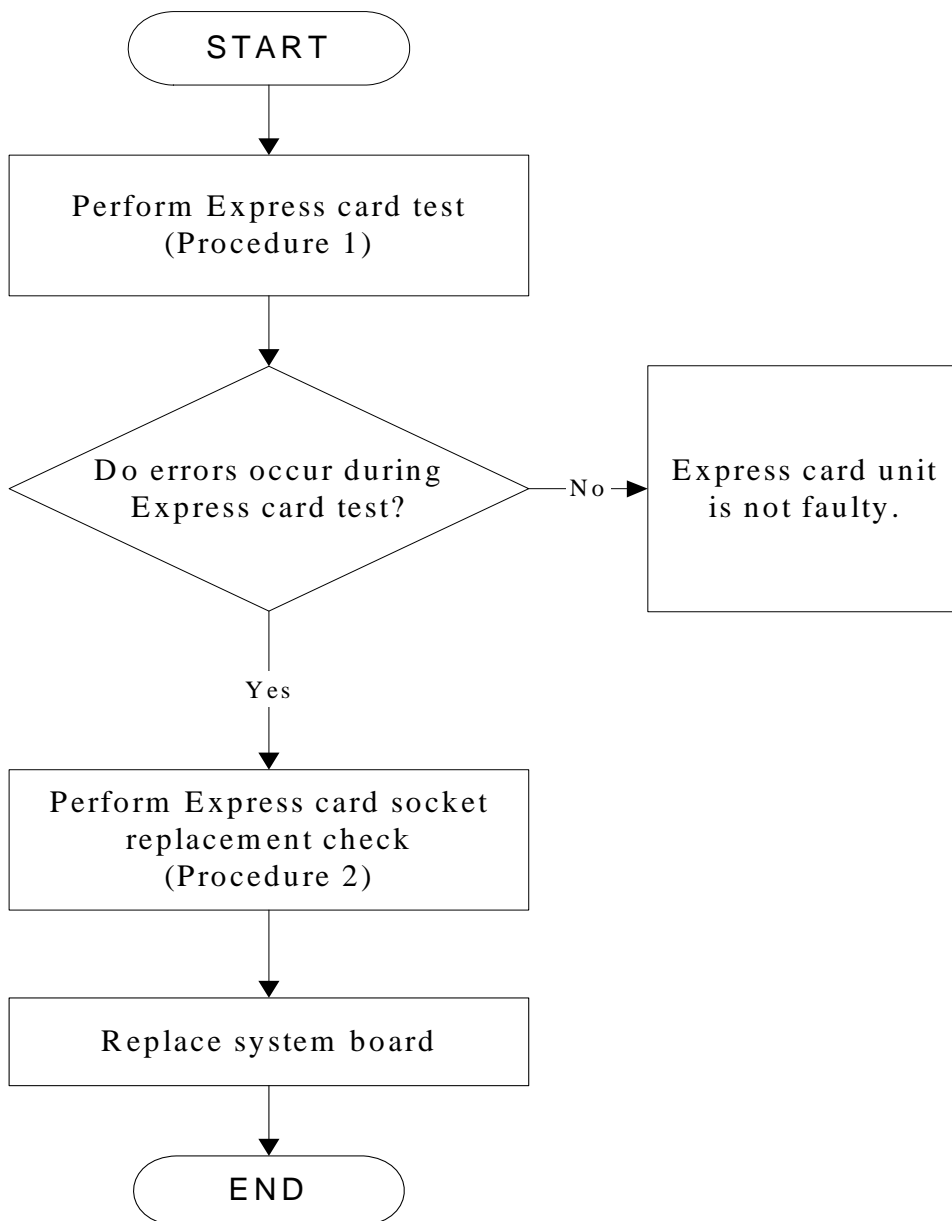

Figure 2-18 Express card troubleshooting process

This section describes how to determine if the Express card player is functioning properly. The process is summarized in Figure 2-13. Perform the steps below starting with Procedure 1 and continuing with the other procedures as required.

Procedure 1: Express card test

Procedure 2: Express card socket replacement check

Procedure 1 Express card test

The Express test card contains a Express test program. Use windows application to check device can work fine or not. If an error occurs. Ensure the card in fully inserted into the socket before running the program.

If an error occurs during the Express card test, perform Procedure 2. If no error occurs, it is likely that the original PC card was faulty.

Procedure 2 Express card socket replacement check

The Express card socket may be damaged or defective, for instance the socket pins can be bent. Disassemble the computer following the steps described in Chapter 4, Replacement Procedures and replace the socket. If the problem persists, the system board may be defective or damaged. Replace the system board with a new one following the steps in Chapter 4.

2.20 HDMI Troubleshooting

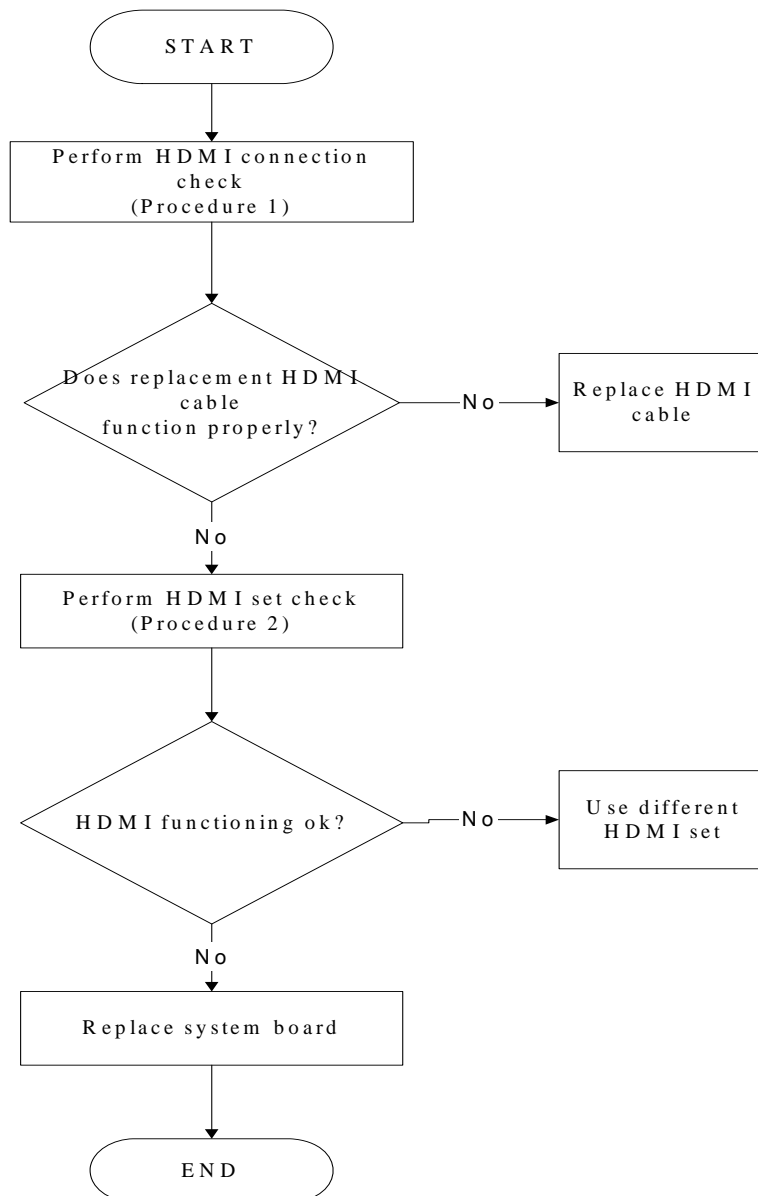

Figure 2-19 HDMI troubleshooting process

To determine if the computer's HDMI port is functioning properly, perform the following procedures. Figure 2-7 outlines the process. Start with Procedure 1 and continue as instructed.

Procedure 1: HDMI connection check

Procedure 2: HDMI set check

Procedure 1 HDMI connection check

The HDMI cable may be damaged or the connections may be loose. Use windows application to check device can work fine or not. Perform Check 1:

- Check 1 Make sure HDMI cable is firmly plugged into both the HDMI set and the HDMI port of the computer. If the cable is connected correctly, go to Check 2.
- Check 2 Make sure the HDMI port is firmly secured to the system board of the computer. If the malfunction remains, go to Check 3.
- Check 3 The HDMI cable may be damaged. Replace with a good cable. If the malfunction remains, go to Procedure 2.

Procedure 2 HDMI set check

The HDMI TV set may be faulty. Perform Check 1:

- Check 1 Try using the set for television reception. If it does not work, the set may be damaged. If the set does work, perform Check 2.
- Check 2 Try connecting a different television to the computer. If the replacement television works, the original set may be damaged. If the replacement set does not work the system board may be damaged. Replace it with a new one following the instructions in Chapter 4.

2.21 E-SATA Troubleshooting

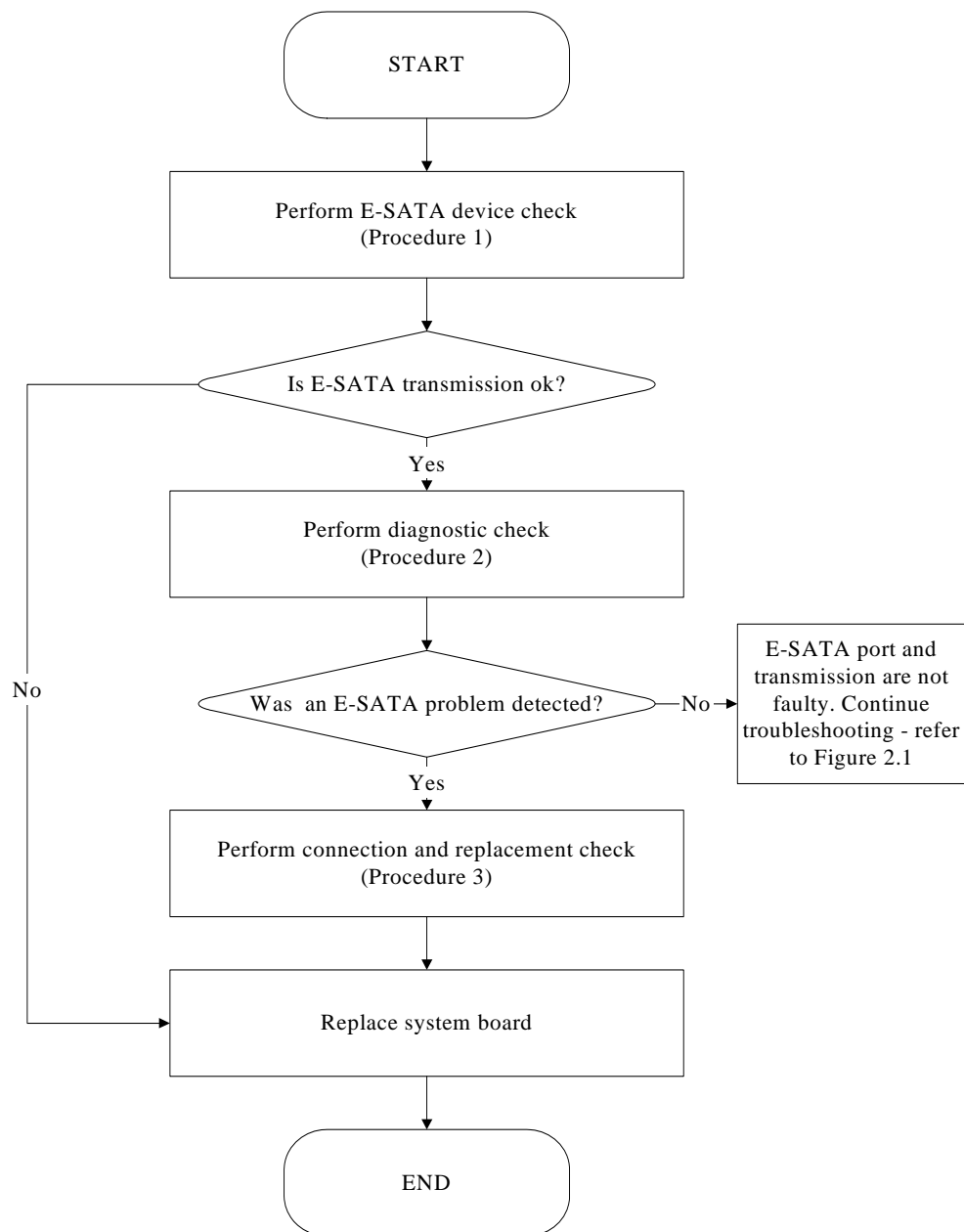

Figure 2-20 E-SATA troubleshooting process

To determine if the computer's E-SATA system is functioning properly, perform the following procedures. Figure 2-24 outlines the process. Start with Procedure 1 and continue with the other procedures as instructed.

- Procedure 1: E-SATA device check
- Procedure 2: Windows Application check
- Procedure 3: Connection and replacement check

Procedure 1 E-SATA device check

Connect an E-SATA device to the computer's E-SATA port, then boot the computer for Windows Vista. The computer should automatically detect the E-SATA device. Check whether the device can transmit data to the computer.

If the device is able to communicate with the computer, the problem may be intermittent or connections may be faulty. Go to Procedure 2.

If communication is impaired, there may be a faulty connection. Go to Procedure 3.

Procedure 2 Windows Application check

Run the Windows Application, which will automatically execute the E-SATA port test for transmission, Tests and Diagnostics for more information on how to run the program.

If an error is located, go to Procedure 3. If an error does not occur, the E-SATA port is functioning properly.

Procedure 3 Connection and replacement check

The transmission cable may be damaged or the connections may be loose. Perform Check 1:

- Check 1 Make sure the transmission cable is firmly plugged into both the E-SATA - compatible device and the E-SATA port of the computer. If the cable is connected correctly, go to Check 2.
- Check 2 Make sure the E-SATA port is firmly secured to the system board of the computer. If the malfunction persists, go to Check 3.
- Check 3 The transmission cable may be damaged. Replace with a good cable. If the malfunction persists, go to Check 4
- Check 4 The system board may be damaged. Replace it with a new one following the instructions in Chapter 4.

2.22 Optical Drive Troubleshooting

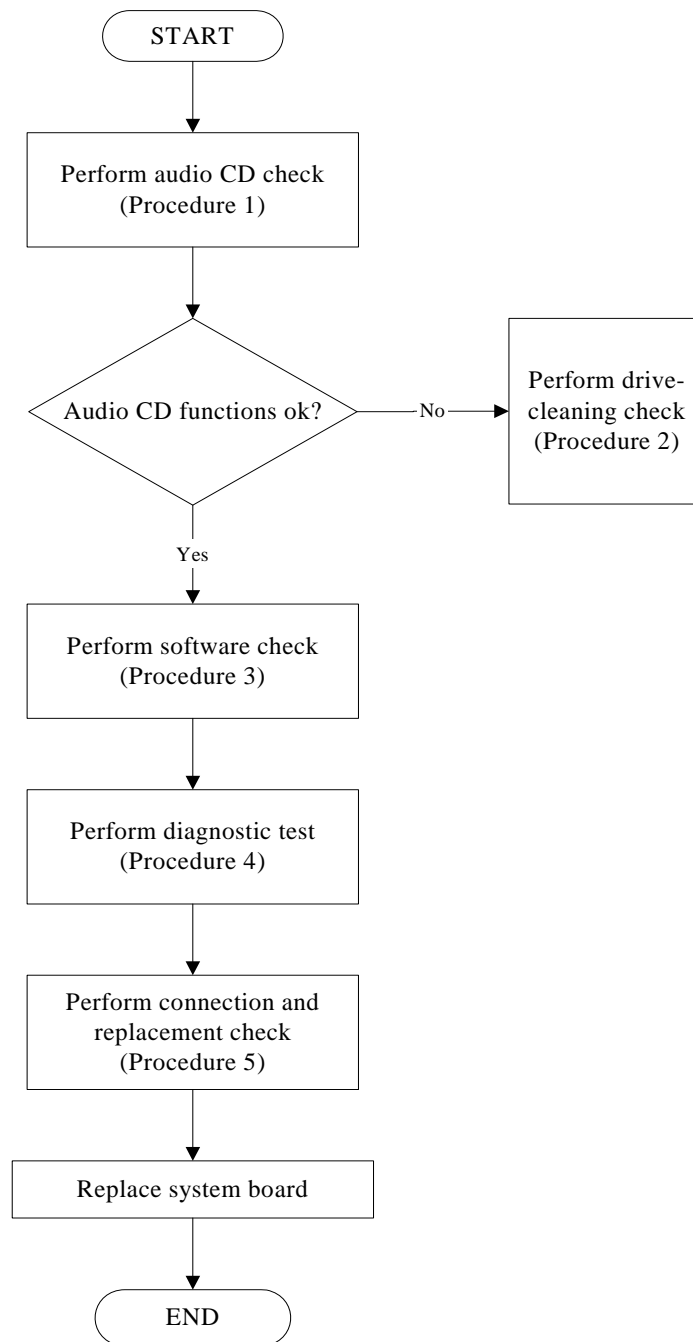

Figure 2-21 Optical drive troubleshooting process

This section describes how to determine if the computer's internal optical drive is functioning properly. The Satellite P200D / P205D Satellite Pro P200D EQUIUM P200D SATEGO P200D Series Maintenance Manual module bays can accommodate the following optical drives:

DVD SuperMulti supporting +-R Double Rayer

Figure 2-11 outlines the process. Perform the steps below starting with Procedure 1 and continue with the other procedures as required.

Procedure 1: Audio CD test

Procedure 2: Drive cleaning check

Procedure 3: Software check

Procedure 4: Connection and replacement check

Procedure 1 Audio CD check

First, insert an audio CD into the CD/DVD drive. Use windows application to check device can work fine or not. If it works, the problem is not with the drive. Go to Procedure 3. If the audio CD does not work, go to Procedure 2. If the CD/DVD LED on the front panel does not light when the disc is played and the drive gives no response, go straight to Procedure 3.

Procedure 2 Drive cleaning check

Insert a CD/DVD drive-cleaning disk into the drive clean according to the drive-cleaning product instructions. If the problem persists, go to Procedure 3.

Procedure 3 Software check

Ensure that the appropriate driver has been installed on the computer for the CD/DVD drive.

Procedure 4 Connection check and replacement check

The optical drive connects to the system board. The drive may be disconnected, or the drive or system board may be damaged. Disassemble the computer following the steps described in Chapter 4, *Replacement Procedures*, and perform the following checks:

- Check 1 Make sure the drive is firmly connected to the system board. If the connection is good and there is still an error, go to Check 2.
- Check 2 The drive or drive cable may be defective or damaged. Replace each with a new one following the steps in Chapter 4, *Replacement Procedures*. If the drive is still not functioning properly, perform Check 3.
- Check 3 The system board may be damaged. Replace it with new one following the instructions in Chapter 4, *Replacement Procedures*.

Chapter 3

Tests and Diagnostics

3. Tests and Diagnostics

3.1	The Diagnostic Test	3
3.2	Executing the Diagnostic Test.....	4
3.3	Display Configuration	8
3.4	Audio sound Test.....	9
3.5	Fan ON/OFF Test.....	9
3.6	Main Battery Charge Test	11
3.7	FDD Test	11
3.8	Memory Check	14
3.9	Keyboard Test	14
3.10	Mouse (Pad) Test	16
3.11	LCD Pixels Mode Test.....	17
3.12	Magnetic switch Test	18
3.13	LAN Test.....	20
3.14	RTC Test	23
3.15	BUTTON Test.....	24
3.16	1st HDDTest	25
3.17	RDMI Test.....	27
3.18	WDMI Test	28
3.19	HDCP Key Check.....	31

3.1 The Diagnostic Test

This chapter explains how to use the Test & Diagnostic program to test the functions of the **(Base on Sunderland 10M/10MG T&D version 1.0)** hardware modules. The Test & Diagnostic Program is stored on the T&D diskettes. The program consists of a series of tests that run automatically when the Diagnostics Program items are selected and executed.

NOTES: *To start the diagnostics, follow these steps*

1. *Check all cables for loose connections.*
2. *Exit this program when you are at Main Menu.*

The TEST & DIAGNOSTIC PROGRAM contains the following functional tests:

- CONFIG CHECK TEST
- Audio sound TEST
- FAN ON/OFF TEST
- MAIN BATTERY CHARGE TEST
- FDD TEST
- Memory check
- KEYBOARD TEST
- MOUSE(PAD) TEST
- LCD PIXELS MODE TEST
- MAGNETIC SWITCH TEST
- LAN TEST
- RTC TEST
- BUTTON TEST
- 1st HDD Test
- RDMI Test
- WDMI Test
- HDCP KEY CHECK

You will need the following equipment to perform some of the Diagnostic test programs.

- The diagnostics USB disk
- A formatted working diskette for the floppy disk drive test (Floppy Disk Drive Test)
- A LAN loopback

3.2 Executing the Diagnostic Test

DOS is required to run the DIAGNOSTICS PROGRAM. To start the DIAGNOSTIC PROGRAM, follow these steps:

Insert the diagnostics USB disk drive and turn on the computer. (The diagnostics diskette contains the Free-DOS boot files.) And then follow the instructions for T&D program installed in USB driver)

The T&D Program can run single test by you press corresponsive English letter of test item, and it also asks you if you like to copy test log file to USB disk as reference at the end of test(s).

The test list is as the following:

- A. CONFIG CHECK TEST
- B. Audio sound TEST
- C. FAN ON/OFF TEST
- D. MAIN BATTERY TEST
- E. FDD TEST
- F. Memory check
- G. KEYBOARD TEST
- H. MOUSE (PAD) TEST
- I. LCD PIXELS MODE TEST
- J. MAGNETIC TEST
- K. LAN TEST
- L. RTC TEST
- M. BUTTON TEST
- N. 1st HDD Test
- O. RDMI Test
- P. WDMI Test
- Q. HDCP KEY CHECK

The below display will show up at the beginning of T&D program

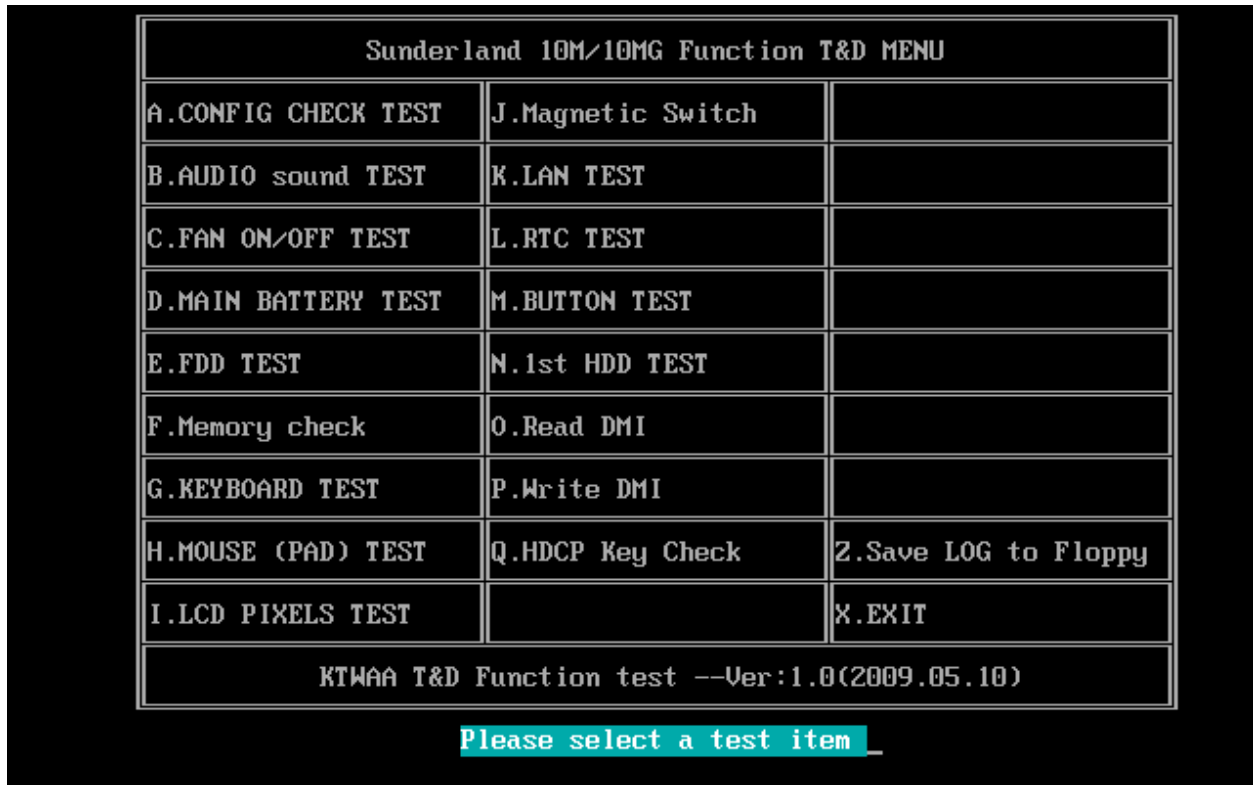

If the test result passes, the following display will show up:



If an error is detected and a test fails, the following message displays:



Then press any key for next actions – the below display presented if copying test log file onto diskette is necessary. This action will be executed when “Y” key pressed.

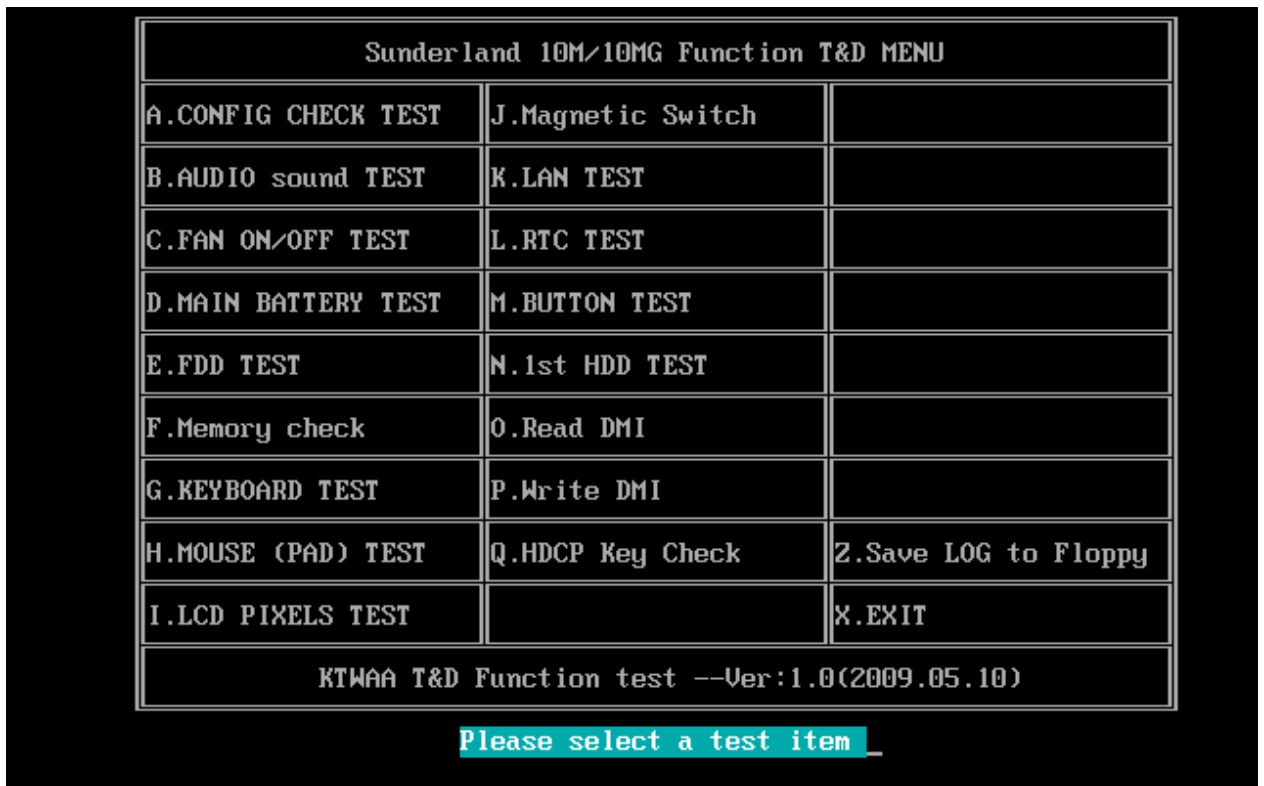

It will skip this process if “N” key pressed.

And then it will check if it’s necessary to leave this program. Program will quit when “Y” key pressed and it will go back main menu for next test if “N” key pressed.

Sunderland 10M/10MG Function T&D MENU		
A.CONFIG CHECK TEST	J.Magnetic Switch	
B.AUDIO sound TEST	K.LAN TEST	
C.FAN ON/OFF TEST	L.RTC TEST	
D.MAIN BATTERY TEST	M.BUTTON TEST	
E.FDD TEST	N.1st HDD TEST	
F.Memory check	O.Read DMI	
G.KEYBOARD TEST	P.Write DMI	
H.MOUSE (PAD) TEST	Q.HDCP Key Check	Z.Save LOG to Floppy
I.LCD PIXELS TEST		X.EXIT
KTWAA T&D Function test --Ver:1.0(2009.05.10)		
Please select a test item _		

3.3 Display Configuration

This Item will show the unit configuration. It includes:

- ◆ CPU (CPU type)
- ◆ DDRAM SIZE
- ◆ Panel ID
- ◆ HDD1 type & capacity (Vendor ID. Model .Firmware)
- ◆ VRAM size / VGA CHIP TYPE
- ◆ Battery cell (3cell;6cell;12cell)
- ◆ Wireless type
- ◆ LAN Type
- ◆ Bluetooth

The screen should display as below:

```
=====
===== Configuration as Below =====
=====
CPUYPE=Penryn-T4200
CPUCache=1024KB
CPUSpeed=2.00GHZ
CPUFSB=800MHZ
DDRAMSIZE=3072MBRAM
PanelID=B173RW01_U0_
HDD1=TOSHIBAMK2555GSX
VRAMSIZE&UGATYPE=INTELM45
BATT=6cell
WirelessTYPE= Atheros0AL00
LANTYPE=8103EL
Bluetooth=YES

ARE YOU TEST OK?[Y,N]?_
```

3.4 Audio sound test

The audio sound test allows the user to aurally confirm the speaker functions. And the speaker will send out music during test.

NOTE: Remember to tune up the volume as “**Maximum**” before this test starts.

Buffalo only have one speaker, no need test Left/Right Speaker

The screen should display as below, indicating whether the test is passed or failed after the question.

```
=====Speaker audio Test=====
1.Please adjust volume to max level.
2.Please listen to speaker will send out sound

Press any key to continue . . . _
```

3.5 Fan ON/OFF Test

The fan test allows the user to test aurally whether the fan is working. And follow the below procedures for this test:

- ◆ The computer will let the fan be “ON” after any key pressed. Feel the wind or listen the rotating sound to check whether the fan is working or not.

NOTE: Remember to approach fan outlet that is near right side of unit whether fan is “ON”.

- ◆ The computer will stop the fan working after any key pressed. Feel the wind or listen the sound to check if the fan is “OFF”.

The screen should display as below, indicating whether the test is passed or failed after the question.

```
**** Fan ON/OFF Test ,Please Listen To The FAN Sound !! ****
Press Any Key To Fan On Test ..

Fan On Test :rotating.. ( Press Any Key To Fan Off Test )
Fan Off Test :stopping..

Do you feel FAN rotating wind?

[Y,N]?
```

3.6 Main Battery Charge Test

NOTE: The AC adaptor should be connected to successfully run this test

- . 65W with 19V DC for UMA SKU
- . 90W with 19V DC for discrease SKU

This test shows and measures the main battery:

- ◆ Battery type (Lion)
 - ◆ Manufacturer (Sanyo/Panasonic/Sony)
 - ◆ Remain charge capacity (0 ~ 100%)
 - ◆ Charge function (PASS/FAIL)
- “Battery Is Full” showed when “remain charge capacities” is 100%

The screen should display as below, if the charge function is OK, will show:.

```
ONLY FOR 87591 T&D Series Battery Test Program.[591] V1.0 2002/07/23
MAIN Battery

Battery Type: Lion
Manufacturer: Sony
Remain charge capacity : 80.0%

Charge Test-> [ PASS ]

Press any key to continue . . .
```

If the charge function is NG, the screen will display as:

```
ONLY FOR 87591 T&D Series Battery Test Program.[591] V1.0 2002/07/23
MAIN Battery

Battery Type: Lion
Manufacturer: Sony
Remain charge capacity : 86.5%

Charge Test-> [ FAIL ]

Press any key to continue . . .
```

3.7 FDD Test

NOTE: Before running the FDD test, prepare a formatted work diskette (1.44 MB). Need to insert FDD when power on machine. Otherwise the Floppy can not be detected.

The Floppy Disk Test includes three subtests of the:

1. Sequential seek/verify function (Range: Track 0 ~ 79)
2. Funnel code seek/verify function (Range: Track 0 ~ 79)
3. Write/Read/Compare pattern function (Range: Track 75 ~ 79)

NOTE: The write-protected device of this formatted diskette should be "Disable".

The subtests run automatically.

NOTE: Press "Esc" key can skip the current subtest.

The screen should display as below, indicating whether the subtests pass or fail when finished.

```
***** Fdd Test Program V1.3 *****  
Testing Driver A: [1.44 MByte (Cyl:80, Head:2, Sec:18)]...  
Testing Seq. seek/verify... Head: 01, Track: 79... [ PASS ]  
Testing Fun. seek/verify... Head: 01, Track: 06...
```

3.8 Memory check

This test will check if the computer's Memory Frequency and Size is correct in every slot.

```
=====
COMPAL Electronic Inc.                               V1.0.0.1
Author : STD.SID TEAM.
WARNING: THIS PROGRAM IS FOR INTERNAL USE ONLY.
Copyright (c) 2008 COMPAL Electronic Inc. All rights reserved.
=====
DIM: 0
      Size0: 1024 MB
      Speed0: 800
      Manufacturer0: 1GA3700

DIM: 2
      Size2: 2048 MB
      Speed2: 800
      Manufacturer2:

are the RAM type is ok? [Y,N]?_
```

3.9 Keyboard Test

The keyboard test checks the all keys function.

NOTE: The Num Lock and the Overlay mode must be off to execute the keyboard test.

Before keyboard test starts, the keyboard matrix code should be chosen as below display:

1. **S** (US, for America)
2. **J** (Japan, for Japan)

3. **K**(UK, for Europe)

When you execute this test, the keyboard layout is drawn on the display. When any key is pressed, the corresponding key on the screen changes to black as shown below.

It will indicate whether the sub test is passed or failed after the question.

US Keyboard

```

Version: 1.60
Keyboard pad sequential test: ECQ60 Keyboard Test Program 46

Esc F1 F2 F3 F4 F5 F6 F7 F8 F9 F10 F11 F12 PS Pau Sc1 Ins HmE PgU
Del End PgD

` 1 2 3 4 5 6 7 8 9 0 - = BS Num / * -
Tab Q W E R T Y U I O P [ ] \ 7 8 9 +
Cap A S D F G H J K L ; ' Enter 4 5 6
Shift Z X C V B N M , . / Shift ↑ 1 2 3 EN
Ctl Fn Win Alt Space Bar Alt Win Ctl ← ↓ → 0 .

Press <Fn+Up> and <Fn+Down> key.
Thank you very much. <Ctrl-Break> Quit
ARE YOU TEST OK?[Y,N]?_

```

Japan keyboard

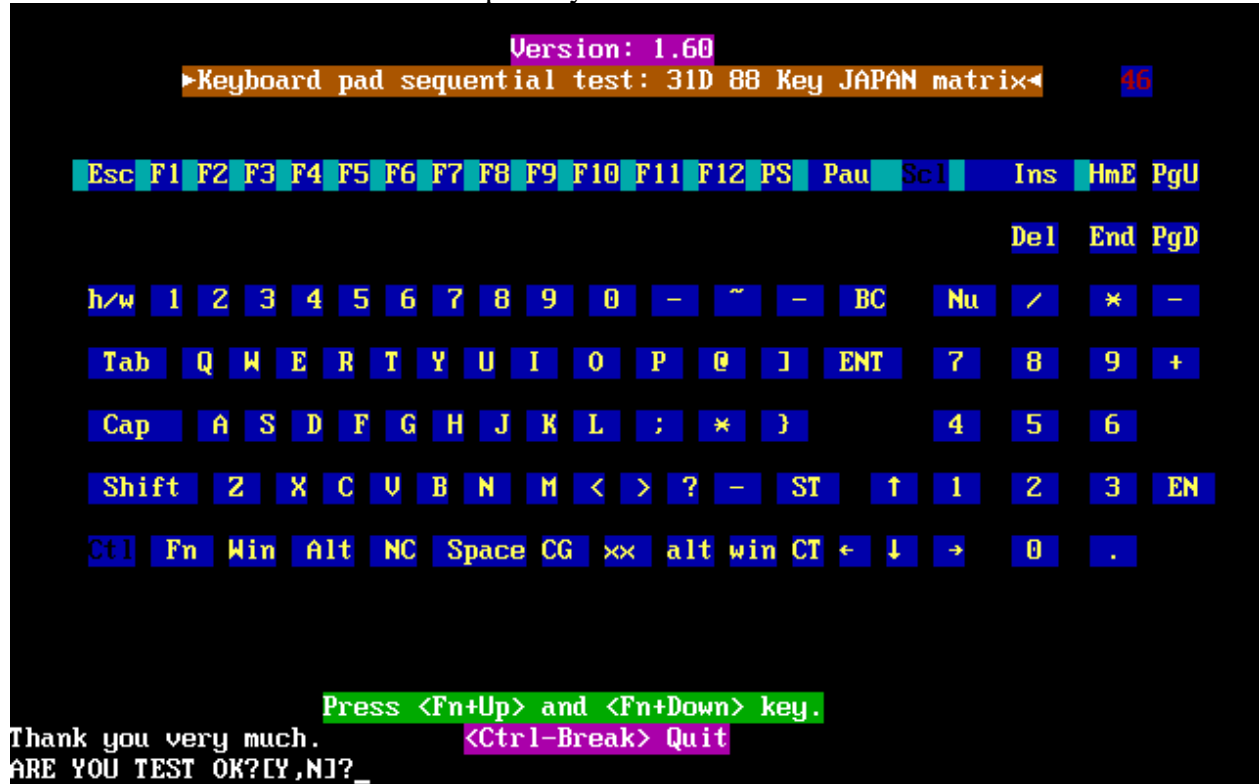

UK keyboard

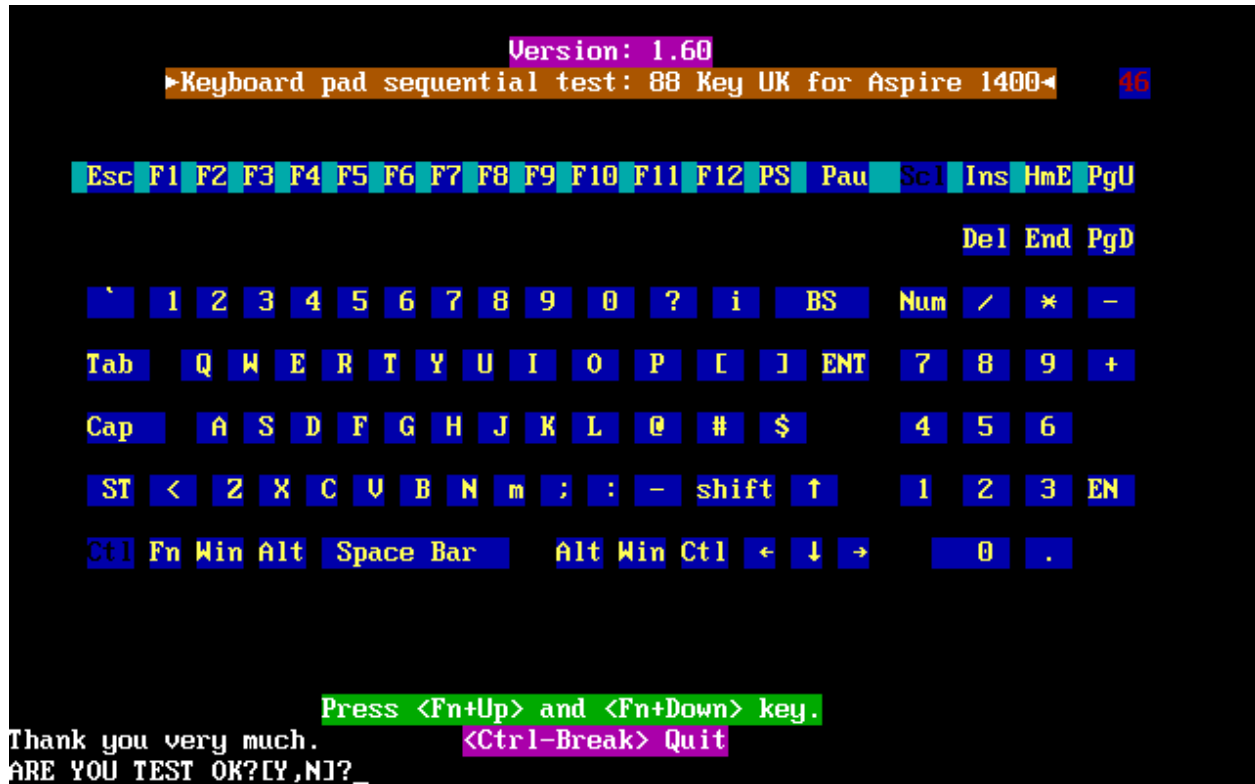

NOTE: The “Fn” key cannot be tested in the keyboard test. To determine whether the “Fn” key is working correctly, press “Fn+F6” or “Fn+F7” keys to check if LCD display brightness change gradually.

3.10 Mouse (Pad) Test

The Mouse test allows the user to select and assign values to the following, using the Touch Pad or “Tab” key to move between selections:

1. Mouse Speed (on a scale from slow to fast)
2. Acceleration (Off, Low, Medium, High)
3. Button Assignments (Left + Right / Right button, either Unassigned or Drag Lock)
4. Swap Buttons (Left /Right)

NOTE: The Touch Pad test cannot be used to test an external USB mouse.

The Touch Pad button subtest allows users to test their Touch Pad buttons. If the buttons are clicked, the cursors should appear in the corresponding box of the button figure that is displayed on the screen as below.



After checking T/Pad buttons and cursor's function, use "Tab" key or use T/Pad cursor to click the "OK" column will end this test.

It will indicate whether the subtests pass or fail after three questions.

NOTE: The above figure has three compartments although the Touch Pad installed may only have two buttons. In this case, the central compartment in the figure does not correspond to any button.

3.11 LCD Pixels Mode Test

This LCD pixels mode test checks whether video display is fine.

This test includes two modes of the test:

1. Text Mode
 - including 40*25 (16 colors) and 80*25 (2/16colors).

2. VGA Mode

- including 320*200 (4/16/256 colors), 640*200 (2/16 colors), 640*350 (2/16 colors), 640*480 (2/16/256 colors), 800*600 (256 colors) and 1024*768 (256 colors).

The screen should display as below, indicating whether the test is passed or failed after the question.

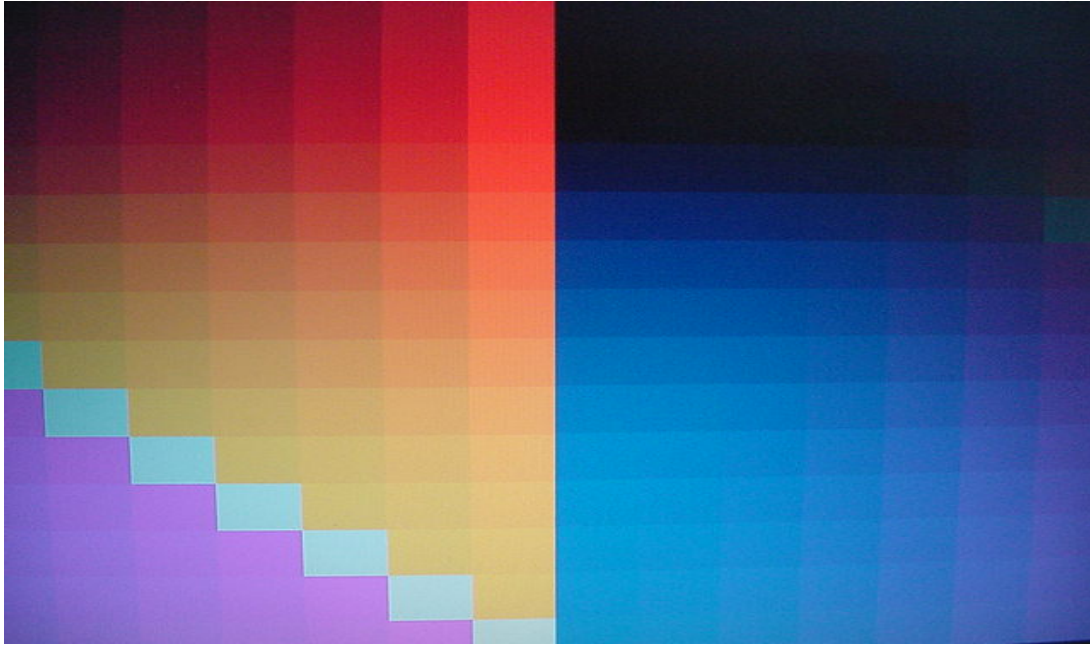

3.12 Magnetic Switch Test

The Magnetic switch test checks the Magnetic function of the unit. When LCD cover closed, the Magnetic should enable to turn off the display.

Follow below steps to run this test:

1. Close the LCD cover.
2. Open the LCD.

3. Tests and Diagnostics

Then it will indicate whether the test is passed or failed.

1>. If the Magnetic switch test fail, it will show below display:

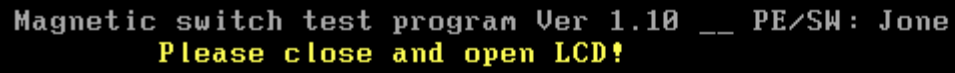

```
Magnetic switch test program Ver 1.10 __ PE/SW: Jone  
Please close and open LCD!
```

2>. If the Magnetic switch test pass, it will show below display:

```
Magnetic Switch test is Pass!  
ARE YOU TEST OK?[Y,N]?
```

3.13 LAN Test

The LAN test checks the LAN full-duplex environment.

NOTE: LAN loopback needs to plug in before test begins.

And LAN information will show on the test screen:

- ◆ IO Base – Port: A000H
- ◆ IRQ – BH, it's "IRQ B".
- ◆ Node – it is "MAC Address".

3. Tests and Diagnostics

- ◆ Line Speed – 1000Mbps or 100Mbps or 10 Mbps.
- ◆ Bus ID – it's "14".

The LAN test includes three subtests of the:

1. Speed1000
2. Speed100
3. Speed10

The subtests run automatically.

```
----- LAN TEST -----  
  
1.Please plug-in the Loopback into LAN port.  
2.Please see test result in middle of display.  
  (Pass: ooo , Fail: xxx )  
  
Press any key to continue . . .
```

The screen should display as below, indicating whether the subtests pass or fail when finished.

```

MP Program for PCI/PCI-E Family LAN Product/Client 1.22 02-01-08 version
IOBASE = A000H IRQ = B H Node:001EEC3EC8DA 1000M: 10K 100M: 5K 10M: 2K
VID =10ECH DID =8136H SVID =1179H SSID =FF00H Lan Adapters: 1
Now is: 1
Open Your MPLAN.CFG in this machine! 100M Link OK 10M Link OK
Test Item Result(Pass/Fail)
1.PG_LAN=false none
2.Reg_R/W=true Pass
3.Speed1000=true none Rxtimeout 1
4.Speed100=true Pass ROK= 2000 TOK= 2000
5.Speed10=true Pass Error= 0
6.Debug=true Txtimeout = 50
7.AutoRun=true

***** Pass in debugging mode *****
Press 'ESC' key to exit .....

E:\LAN>

```

If an error is detected and a test fails, the following message displays:

```

F A I L

Press any key to continue . . .

```

3.14 RTC Test

Checks the computer's RTC (Real Time Clock) and calendar functions by comparing the DOS and CMOS values.

The test runs automatically.

The screen should display as below, indicating whether the test is passed or failed when finished.

```
====RTC TEST====

Please Check the result after test.

Press any key to continue . . .

Wait for zero counter...
Testing..
DOS TIME = 22:33:48.04(8122804), CMOS TIME = 22:33:48(8122800)
DOS DATE: 09/19/2002, CMOS DATE: 09/19/2002
DATE & TIME test [ PASS ]

Press any key to continue . . .
```

3.15 BUTTON TEST

NOTE: Only for five buttons SKU.

The tool for five buttons SKU, the Screen would display as below:

```
====-button TEST====  
  
Please Check the result after test.  
the tool only for five button SKU  
  
Press any key to continue . . . _
```

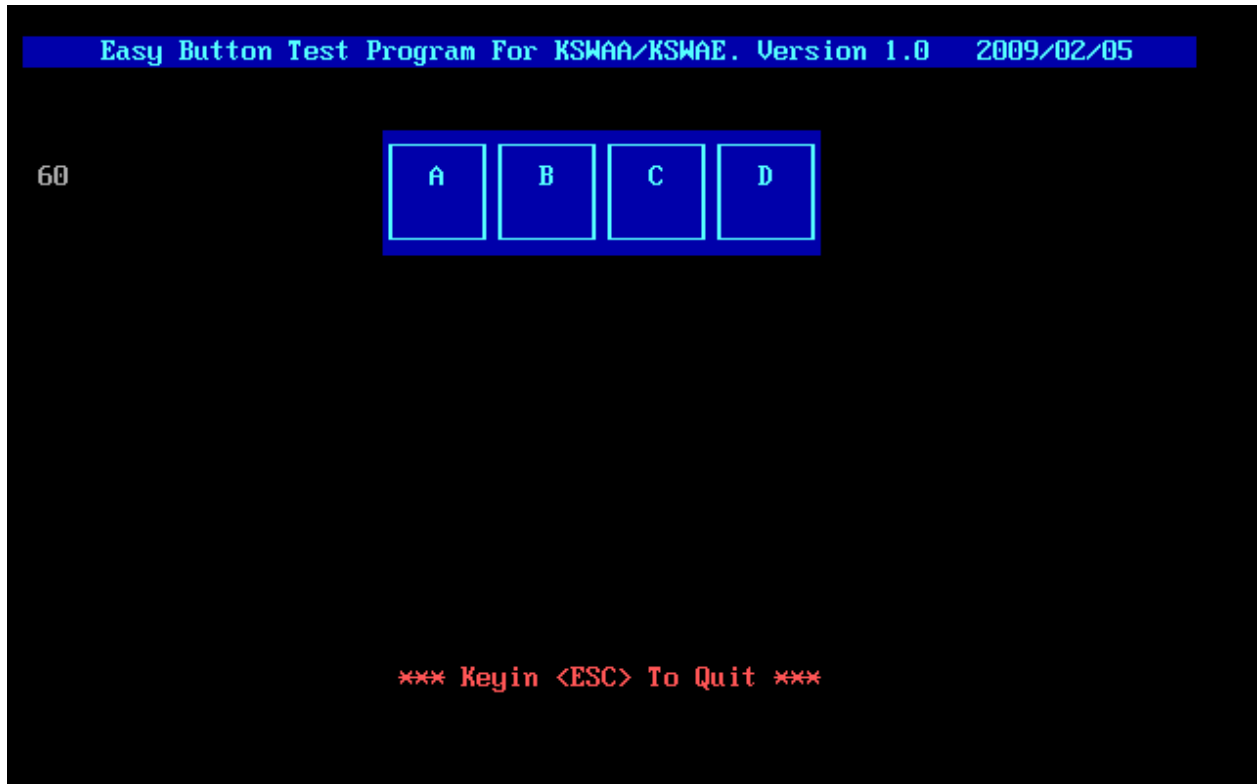

Mechanical type buttons x 4 to relate with above showed.

BUTTON A → Play/Pause button

BUTTON B → FR

BUTTON C → FF

BUTTON D → Mute

3.16 1st HDD Test

The HDD test allows the user to verify the 1st HDD ok or not. First, please select HDD test method, Screen would display as below:

```
===== HDD TEST =====  
1.HDD W/R test(all surface)  
2.Partial W/R + Random W/R  
[1,2]?
```

After you select the method, then input password: “hard disk”, if input password is Right, the screen would display as below:

```
Input password is Right  
Press any key to Test HDD function  
  
Press any key to continue . . .
```

If input password is wrong, the screen would display as below:

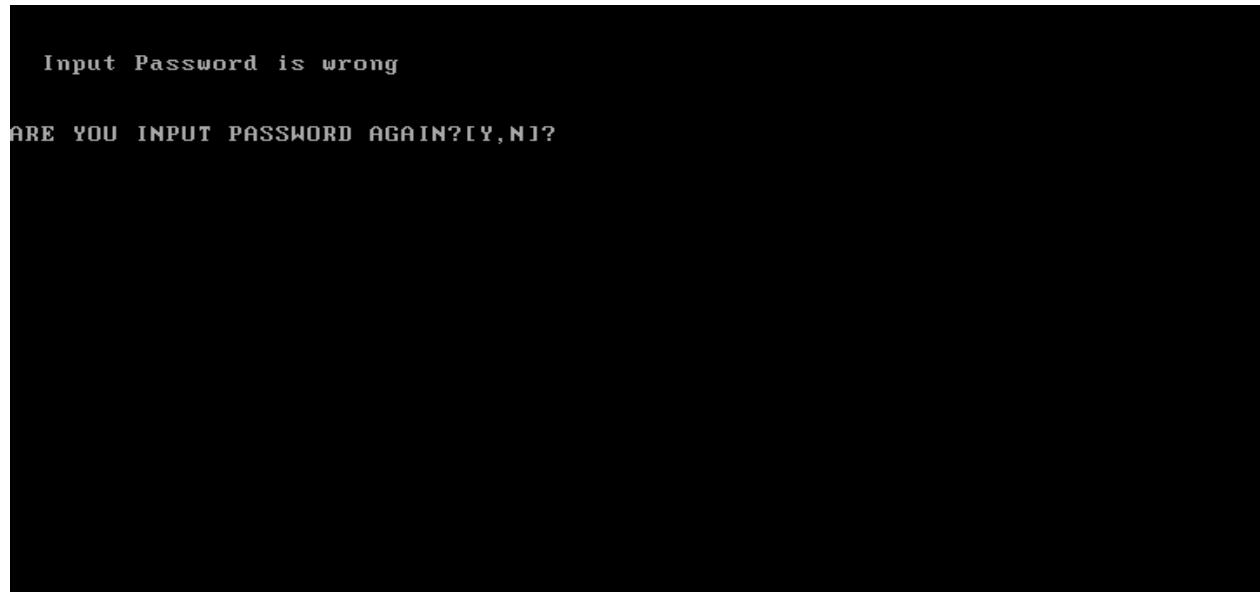

The screen will display as below picture to show the subtest is passed or failed when finished:

If it is show the picture as below, it means HDD function is OK

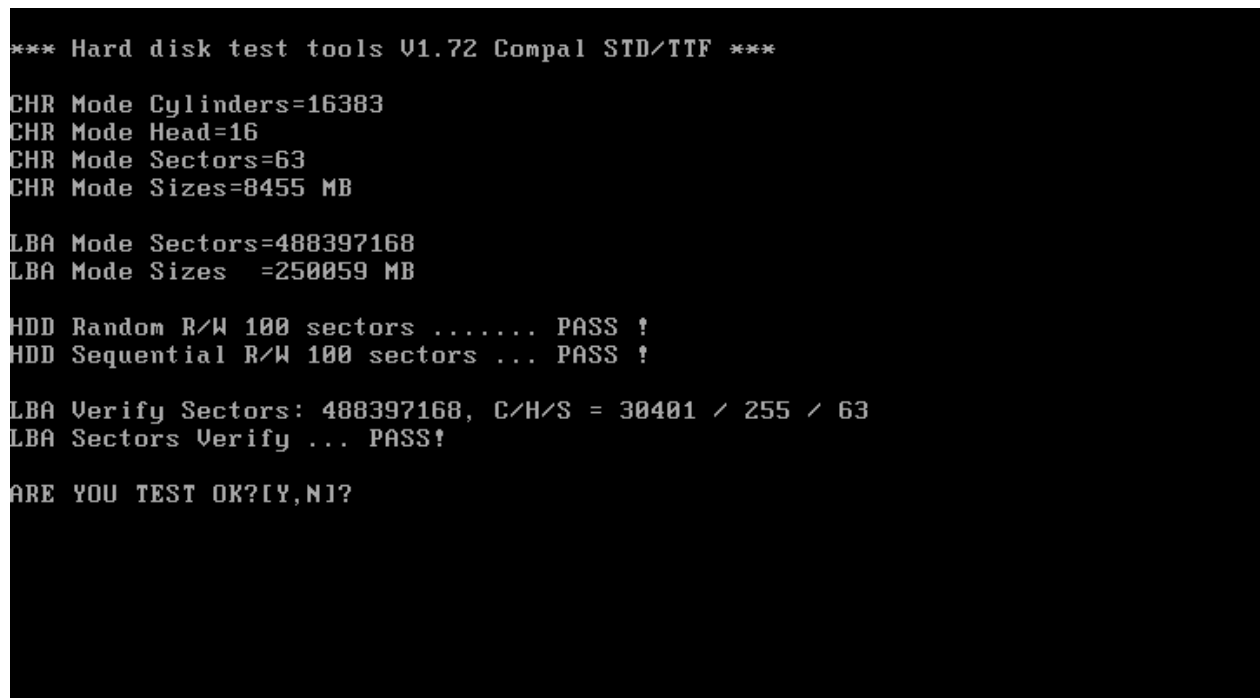

If the picture shows as below, it means he HDD function is NG

```
*** Hard disk test tools V1.60 Compal STD/TTF ***  
Reset DISK1 .....Pass !  
Error ! Can't use Enhanced Disk Drive Support Function  
ARE YOU TEST OK?[Y,N]?
```

3.17 Read DMI

Compal write Toshiba Part No (version), Toshiba Serial No (Serial No), Product Name, OEM string and UUID, If you want to double check the DMI data, please select Read DMI item, the figure below will be displayed:

```
Manufacturer : TOSHIBA
Product_Name : Satellite A355D
Serial_Number : X8116579K
Version      : PSALEU-004005
Asset_Number : *
UUID        : 6C64768B8CE211DD8A58001EEC40A110
OEM_Strings : PSALEU-004005,SQ004806V04,11Q40
Are the DMI data is OK? [Y,N]?
```

3.18 Write DMI

When you want to write DMI data, please select which data you want to write, the figure below will be displayed:

1. Write OME string
2. Write Version
3. Write Serial
4. Write Product

```
please choice the item
1: Write OEM String
2: Write Version
3: Write Serial
4: Write Product
please enter the num you choose:
```

After write OK, you should reboot the system that can make the setting effective, or you can write next data before reboot system, the figure below will displayed:

```
please choice the item
 1: Write OEM String
 2: Write Version
 3: Write Serial
 4: Write Product
please enter the num you choose: 1
please enter the OEM String: psmadk-011002

Modify OEM String to psmadk-011002

Jump to EEPROM Bank : 0

Erase EEPROM Start Offset : a0 End Offset:dd Size:62
.....
Jump to EEPROM Bank : 0

Flash EEPROM Start Offset : a0
.....
Confirm the data ?
.....
Modify EM String success!

*****Please reboot the system.To make the setting effective
*****Do you want to modify other dmi ? *****
Press Y for Yes or N for No:
```

***NOTE:** should input correct DMI data, and should reboot the system that can make the setting effective.*

3.18 HDCP Key Check

This test will check HDCP key has been written into your computer successful or not.

NOTE: Only UMA(GM45) SKU unit support HDCP function

```
==== HDCP KEY CHECK====  
  
Please Check the result after test.  
  
===Notice:only UMA sku have HDCP function===  
  
KSV = 3C 61 75 AB 8A  
Chip-Uniq EKS initialized !  
ARE YOU TEST OK? [Y,N]?_
```

If the picture shows as below, it means the HDCPKEY function is NG

```
C:\>hdcpkey /ksv
Family EKS NOT initialized !
C:\>
```

Chapter 4

Replacement Procedures

Chapter 4 Contents

4.1	General	4-1
	Safety Precautions	4-3
	Before You Begin.....	4-5
	Disassembly Procedures.....	4-6
	Assembly Procedures	4-6
	Tools and Equipment	4-7
	Screw Tightening Torque.....	4-7
	Colors of Screw Shanks	4-8
	Symbols of Screws on the Laptop Body	4-8
	Symbol examples	4-8
4.2	Battery	4-9
	Removing the Battery Pack.....	4-9
	Installing the Battery Pack	4-10
4.3	HDD	4-11
	Removing the HDD.....	4-11
	Installing the HDD	4-13
4.4	Memory	4-15
	Removing the Optional Memory.....	4-15
	Installing the Optional Memory	4-16
4.5	ODD	4-17
	Removing the ODD Bay Module.....	4-17
	Installing the ODD Bay Module	4-18
	Disassembling the ODD Drive.....	4-18
	Assembling the ODD Drive	4-19
4.6	Keyboard Cover and Keyboard.....	4-20
	Removing the Keyboard Cover and Keyboard	4-20
	Installing the keyboard Cover and Keyboard.....	4-22
4.7	Logic Upper Assembly.....	4-23

	Removing the Logic Upper Assembly	4-23
	Installing the Logic Upper Assembly	4-25
4.8	Function Board	4-26
	Removing the Function Board	4-26
	Installing the function board	4-26
4.9	Bluetooth Card	4-27
	Removing the Bluetooth card.....	4-27
	Installing the Bluetooth card	4-28
4.10	Touch Pad Button Board and Bracket.....	4-29
	Removing the touch pad button board and bracket.....	4-29
	Installing the Touch Pad Button board and Bracket	4-30
4.11	Speakers	4-31
	Removing the Speakers.....	4-31
	Installing the Speakers	4-31
4.12	Display Assembly	4-33
	Removing the Display Assembly	4-33
	Installing the Display Assembly	4-34
4.13	Thermal Fan	4-35
	Removing the Thermal Fan.....	4-35
	Installing the Thermal Fan	4-35
4.14	Motherboard	4-36
	Removing the Motherboard	4-36
	Installing the Motherboard.....	4-39
4.15	USB Board	4-41
	Removing the USB Board.....	4-41
	Installing the USB Board	4-41
4.16	ODD Board	4-42
	Removing the ODD Board.....	4-42
	Installing the ODD Board	4-42
4.17	Thermal Module and VGA Board (Optional).....	4-43
	Removing the Thermal Module and VGA Board.....	4-43
	Installing the VGA Board and Thermal Module.....	4-44

4 Replacement Procedures

4.18	CPU	4-46
	Removing the CPU.....	4-46
	Installing CPU	4-47
4.19	WLAN Card	4-48
	Removing the WLAN Card.....	4-48
	Installing the WLAN Card	4-48
4.20	Modem Card (Optional)	4-49
	Removing the Modem Card	4-49
	Installing the Modem Card.....	4-49
4.21	LCD Bezel Assembly	4-50
	Removing the LCD Bezel Assembly	4-50
	Installing the LCD bezel	4-52
4.22	LCD Module	4-55
	Removing the LCD Module	4-55
	Installing the LCD Module	4-58
4.23	CMOS Board and Microphone (Optional).....	4-60
	Removing the CMOS Board and Microphone	4-60
	Installing the CMOS Board and Microphone	4-60

Figures

Figure 4.1 Removing the Battery Pack 4-9

Figure 4.2 Removing the HDD door 4-11

Figure 4.3 Removing the HDD plate..... 4-13

Figure 4.4 Removing the RAM door..... 4-15

Figure 4.5 Removing the RAM from the laptop 4-16

Figure 4.6 Removing the ODD Bay module 4-17

Figure 4.7 Removing the bracket from the ODD drive..... 4-18

Figure 4.8 Removing the keyboard cover 4-20

Figure 4.9 Removing screws and releasing hooks from the keyboard..... 4-21

Figure 4.10 Removing the keyboard 4-22

Figure 4.11 Removing the screws from the bottom of the laptop 4-23

Figure 4.12 Removing six screws from under the keyboard..... 4-24

Figure 4.13 Detaching cables from under the keyboardp 4-25

Figure 4.14 Removing the function board..... 4-26

Figure 4.15 Removing the Bluetooth card 4-27

Figure 4.16 Removing the screws from the touch pad button board 4-29

Figure 4.17 Removing the touch pad bracket 4-30

Figure 4.18 Removing the speakers 4-31

Figure 4.19 Removing the display assembly..... 4-33

Figure 4.20 Removing the hinge brackets..... 4-34

Figure 4.21 Removing the thermal fan from the logic lower assembly 4-35

Figure 4.22 Removing the motherboard from logic lower assembly..... 4-36

Figure 4.23 Removing the DC IN connector and cable 4-37

Figure 4.24 Picking up the motherboard 4-37

Figure 4.25 Aligning the motherboard connectors..... 4-39

Figure 4.26 Installing the DC IN connector 4-40

Figure 4.27 Removing the USB Board 4-41

Figure 4.28 Removing the ODD Board..... 4-42

Figure 4.29 Removing the Thermal Module 4-44

Figure 4.30 Removing the VGA Board..... 4-44

4 Replacement Procedures

Figure 4.31	Reapply Shinetsu 7726 grease on the thermal module and remove any release papers	4-45
Figure 4.32	Removing the CPU	4-46
Figure 4.33	Removing the WLAN card	4-48
Figure 4.34	Removing the modem card	4-49
Figure 4.35	Removing the LCD Bezel Assembly	4-50
Figure 4.36	Taking out the hinge wall	4-51
Figure 4.37	Removing the bezel from the hinge wall	4-51
Figure 4.38	Reroute the cables	4-52
Figure 4.39	Pressing the bezel hinge wall	4-53
Figure 4.40	Pressing the bezel downside hook	4-53
Figure 4.41	Pressing the left and right side of the bezel	4-54
Figure 4.42	Pressing the bezel upside hooks	4-54
Figure 4.43	Removing the LCD Module from the LCD cover assembly	4-55
Figure 4.44	Removing the LCD Hinge Assembly	4-56
Figure 4.45	Removing the LVDS cable	4-57
Figure 4.46	Installing the LCD Hinge Assembly	4-58
Figure 4.47	Removing the LCD Module from the LCD cover assembly	4-59
Figure 4.48	Removing the CMOS board and Microphone	4-60

Fehler! Verwenden Sie die Registerkarte 'Start', um 標題 2 dem Text zuzuweisen, der hier angezeigt werden soll. Fehler! Verwenden Sie die Registerkarte 'Start', um 標題 2 dem Text zuzuweisen, der hier angezeigt werden soll.

4 Replacement Procedures

4.1 General

This chapter explains how to disassemble the laptop and replace Field Replaceable Units (FRUs). Some replacement procedures may not require you to remove all the surrounding FRUs to replace only one FRU. The chart below shows the FRUs in the order in which they should be removed in a top-down manner, irrespective of their physical locations. The FRUs shown in the top area of the chart should normally be removed before removing the FRUs shown in the bottom area. To replace the FRUs, first identify the suspect FRU for the system failure. Next, according to this chart, determine the FRUs that need to be removed before removing the suspect FRU. After you determine those FRUs, go to the appropriate sections according to the section numbers shown in the boxes. Then, start removal and replacement.

4 Replacement Procedures Fehler! Verwenden Sie die Registerkarte 'Start', um 標題 2 dem Text zuzuweisen, der hier angezeigt werden soll. Fehler! Verwenden Sie die Registerkarte 'Start', um 標題 2 dem Text zuzuweisen, der hier angezeigt werden soll.

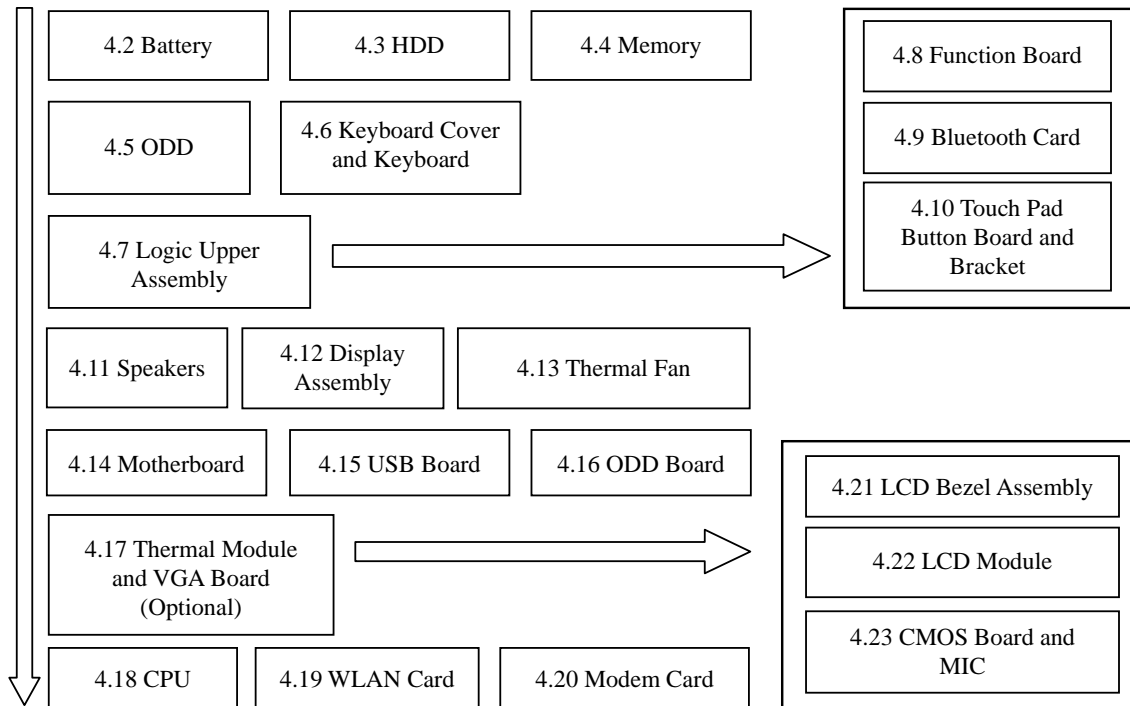

How to use the chart (two examples):

- For removing the Motherboard:
First, remove parts from 4.6-4.7 Keyboard, Logic Upper Assembly and then parts 4.11-13 Speakers, Display Assembly and Thermal Fan.
- For removing the LCD Module:
First, remove 4.21 LCD Bezel Assembly, then remove 4.22 LCD Module.

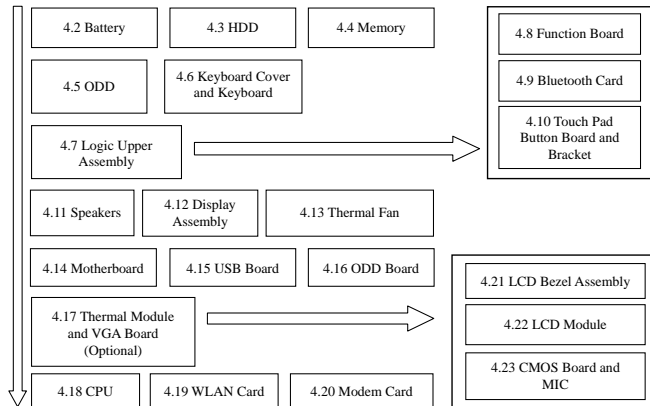

Fehler! Verwenden Sie die Registerkarte 'Start', um 標題 2 dem Text zuzuweisen, der hier angezeigt werden soll. Fehler! Verwenden Sie die Registerkarte 'Start', um 標題 2 dem Text zuzuweisen, der hier angezeigt werden soll.

4 Replacement Procedures

Safety Precautions

Before you begin disassembly read the following safety precautions carefully. Be sure to follow them while you are working.

DANGER:

- 1. Always use the genuine batteries or replacement batteries authorized by Toshiba. Batteries other than those differ in specifications and are incompatible with the laptop. They may burst or explode. To avoid leakage of alkaline solutions, never heat or disassemble the battery packs. Never throw the battery packs into a fire. If this is violated, they will explode.*
- 2. The components such as the power supply and inverter carry high voltages. When you partially disassemble the laptop and turn on the components, use extreme care not to touch the connectors and components to avoid the risk of electrical shock. Do not disassemble individual components during first-level maintenance.*

WARNING:

- 1. To avoid the risk of electrical shock, turn the laptop off and remove the AC adapter from the electrical outlet.*
- 2. Because the battery in the laptop is left charged, the risk of electrical shock remains even after the AC adapter is removed from the electrical outlet. To avoid the risk of electrical shock, be sure to remove any metal jewelry or accessories such as necklaces, bracelets, and rings before starting work. Never work with damp or wet hands.*
- 3. To avoid personal injury, use care to avoid the sharp edges or corners of the components.*

4 Replacement Procedures Fehler! Verwenden Sie die Registerkarte 'Start', um 標題 2 dem Text zuzuweisen, der hier angezeigt werden soll. Fehler! Verwenden Sie die Registerkarte 'Start', um 標題 2 dem Text zuzuweisen, der hier angezeigt werden soll.

CAUTION:

1. Before replacing a component, make sure that the replacement component meets the required specifications. To avoid laptop failures, never use components that do not meet the specifications.
2. To avoid internal damage such as short circuits and fire, never drop metal objects such as screws, pins, paper clips, etc. into the components. When a screw is removed, be sure to replace a screw that is the same size as the original screw. Make sure that all the screws are fastened securely. Loose screws can cause short circuits, overheating, smoke, or fire.
3. Before removing a FRU or other component, make sure that all the component cables have been disconnected to avoid the risk of electrical shock caused by accidental contact with the energized components.
4. For AC input, be sure to use the AC adapter and AC power cable that come with your laptop or Toshiba-recommended equivalents.
5. To avoid the risk of electrical shock, make sure that all the replacement components meet the specifications of the laptop and that all the cables and connectors are fastened securely.
6. Inside the PC are components that become hot during operation (such as the CPU and cooling module). To avoid burns, let the hot components cool down before starting inspection or repair task.

Fehler! Verwenden Sie die Registerkarte 'Start', um 標題 2 dem Text zuzuweisen, der hier angezeigt werden soll. Fehler! Verwenden Sie die Registerkarte 'Start', um 標題 2 dem Text zuzuweisen, der hier angezeigt werden soll.

4 Replacement Procedures

Before You Begin

Before you begin to disassemble the laptop, keep in mind the precautions and advice in this section. Always begin disassembly by removing the AC adapter and battery pack. Remove the optional parts and accessories as well. The procedures for removing the batteries will be explained later.

Disassemble the laptop only when an abnormality has occurred.

Use only the recommended tools.

To run and store the laptop, be sure to prepare a working environment that is free from:

- Dust and contaminants
- Static electricity
- Extremely high or low temperatures and extremely high humidity

Run the diagnostic tests explained in Chapter 2 of this manual to identify the FRU that has probably caused the system failure.

Perform only the required machine operations. Use only the disassembly and reinstallation procedures described in this manual.

Place the removed components in a safe place away from the laptop so that they are not damaged or get in the way of you doing your work.

Normally, a number of screws need to be removed or replaced during disassembling. Place the removed screws in a safe place so that you can easily find the right screws for the right components.

When assembling the laptop, use the specified screws to fasten the parts to the specified locations. See the appropriate explanations and figures for screw sizes.

To avoid personal injury, use care to handle components that have sharp edges or corners.

After you have replaced a FRU, check that the FRU works correctly to ensure normal laptop operation.

4 Replacement Procedures Fehler! Verwenden Sie die Registerkarte 'Start', um 標題 2 dem Text zuzuweisen, der hier angezeigt werden soll. Fehler! Verwenden Sie die Registerkarte 'Start', um 標題 2 dem Text zuzuweisen, der hier angezeigt werden soll.

Disassembly Procedures

The cable connectors come in these two basic types:

- Pressure plate connectors
- Normal pin connectors

To remove a pressure plate connector, pull up the tabs on either side of the connector's plastic pressure plate and gently pull the cable out of the connector. To reconnect the cable to the pressure plate's connector, raise the pressure plate up to a satisfactory height and slide the cable into the connector. Secure the cable in the correct position by pressing down the sides of the pressure plate so that the plate is flush with the sides of the connector. Grasp and pull the cable gently to check that the cable is connected firmly. If the cable came off the connector, reinsert the cable by raising the pressure plate up to a satisfactory height.

Normal pin connectors are used for all the other types of cables. These connectors can be installed or removed by simply inserting them or pulling them out.

Assembly Procedures

You have to reassemble the laptop after you have disassembled the laptop and fixed the component that caused the problem.

When reassembling the laptop, keep the following general guidelines in mind:

- Take your time to carry out the suggested instructions completely. Hurried reassembly can often cause problems.
- Check that all the cable and connectors are fastened securely.
- Before securing the FRUs or other parts, check that the cables are not caught by the screws or FRUs.
- Check that all the latches are closed securely.
- Check that all the required screws are used to secure the FRUs. Using wrong screws can damage the threads or heads of the screws or does not ensure that the FRUs are secure.

After installing a FRU, make sure that the FRU and laptop work normally.

Fehler! Verwenden Sie die Registerkarte 'Start', um 標題 2 dem Text zuzuweisen, der hier angezeigt werden soll. Fehler! Verwenden Sie die Registerkarte 'Start', um 標題 2 dem Text zuzuweisen, der hier angezeigt werden soll.

4 Replacement Procedures

Tools and Equipment

For your safety and that of other people in the working environment, it is strongly recommended that you use electrostatic discharge (ESD) equipment. The proper use of this equipment will ensure successful repair work and reduce the costs for repairing damaged components. The equipment and tools required for disassembly and reassembly are:

- One 2 mm Phillips screwdriver
- One 4 mm flat-blade screwdriver
- Torx screwdriver
- Tweezers (for pulling out screws)
- ESD mats (for the floor and work desks)
- An ESD wrist strap or heel grounder
- Anti-static carpets or flooring
- Air ionizers (for highly electrostatic sensitive areas)
- A plastic card (in credit card size)

Screw Tightening Torque

To secure screws, follow the torque values listed below. Over tightening can damage components and screws. Under tightening can loosen the screw or cause screws to come off, which may result in short circuits or other damage.

- | | |
|--|------------------------|
| <input type="checkbox"/> M2 (2 mm) | 0.22 N·m (2.2 kgf·cm) |
| <input type="checkbox"/> M2.5 (2.5 mm) | 0.36 N·m (3.5 kgf·cm) |
| <input type="checkbox"/> M3 (3 mm) | 0.51 N·m (5.0 kgf·cm) |
| <input type="checkbox"/> M2.5x4 PSP TITE screws | 0.204 N·m (2.0 kgf·cm) |
| <input type="checkbox"/> M2.5x6 GIZA TITE screws | 0.36 N·m (3.5 kgf·cm) |

4 Replacement Procedures Fehler! Verwenden Sie die Registerkarte 'Start', um 標題 2 dem Text zuzuweisen, der hier angezeigt werden soll. Fehler! Verwenden Sie die Registerkarte 'Start', um 標題 2 dem Text zuzuweisen, der hier angezeigt werden soll.

Colors of Screw Shanks

For easy identification of the correct screws, the screw shanks are colored according to their lengths, as follows:

- Screws of an odd-numbered length Blue
- Screws of a special length Black
(Screws of a special length are those of a length having decimal places, eg - 2.5 mm).

Symbols of Screws on the Laptop Body

For easy maintenance, the screw types are shown on the laptop body as symbols. A symbol consists of a letter representing the screw type and a numeral representing the screw length.

- Screw type Letter
- Bind screw B (stands for bind)
- Flat-head screw F (stands for flat-head)
- Super flat-head screw S (stands for super flat-head)
- Tapping screw T (stands for tapping)
- Other screws U (stands for unique-pan head screws, studs, etc.)

Symbol examples

- 6 mm bind screw B6
- 12 mm bind screw B12
- 5 mm stud U5
(The numeral represents the rounded length of the threaded portion regardless of the entire stud length.)

Fehler! Verwenden Sie die Registerkarte 'Start', um 標題 2 dem Text zuzuweisen, der hier angezeigt werden soll. Fehler! Verwenden Sie die Registerkarte 'Start', um 標題 2 dem Text zuzuweisen, der hier angezeigt werden soll.

4 Replacement Procedures

4.2 Battery

Removing the Battery Pack

Remove the battery pack according to the following procedures and Figure 4.1.

CAUTION: When handling the battery packs, use care not to short circuit the terminals. Do not drop, hit, twist, or bend the battery packs. Do not scratch or break up their casing.

1. Turn the laptop upside down so that the bottom is facing you.
2. Slide out the battery lock.
3. Slide the battery release latch and remove the battery pack from the laptop.

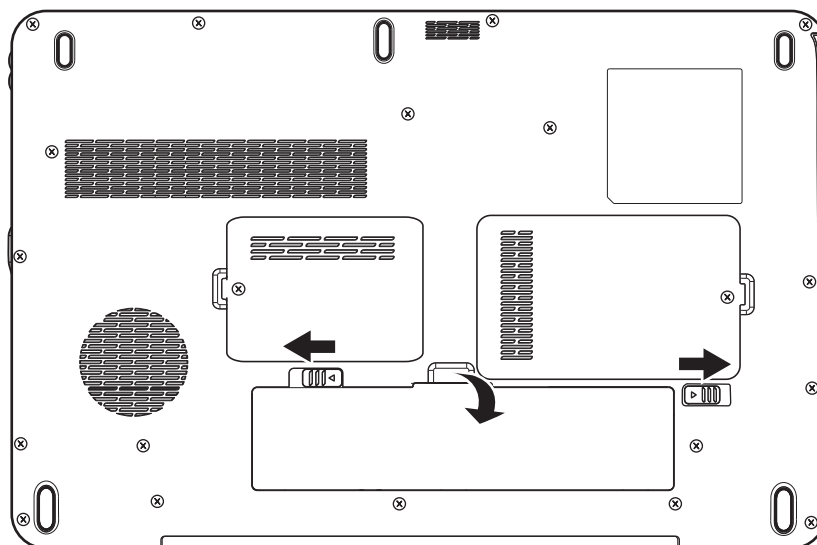

Figure 4.1 Removing the Battery Pack

NOTE: Dispose of the used battery packs as required by local ordinances or regulations.

4 Replacement Procedures Fehler! Verwenden Sie die Registerkarte 'Start', um 標題 2 dem Text zuzuweisen, der hier angezeigt werden soll. Fehler! Verwenden Sie die Registerkarte 'Start', um 標題 2 dem Text zuzuweisen, der hier angezeigt werden soll.

Installing the Battery Pack

Install the battery pack according to the following procedures.

CAUTION: *The battery packs contain a lithium ion battery, which can explode due to improper replacement, use, handling, or disposal. Always dispose of the battery packs as required by local ordinances or regulations. Use only replacement batteries recommended by Toshiba.*

NOTE: *Visually check the battery's terminals. If they are dirty, clean them with a dry cloth.*

1. Gently insert a new or recharged battery pack into place. Check that the battery release latch slides in and stops with a click.
2. Slide in the battery lock.

Fehler! Verwenden Sie die Registerkarte 'Start', um 標題 2 dem Text zuzuweisen, der hier angezeigt werden soll. Fehler! Verwenden Sie die Registerkarte 'Start', um 標題 2 dem Text zuzuweisen, der hier angezeigt werden soll.

4 Replacement Procedures

4.3 HDD

Removing the HDD

CAUTION: Do not press on the top or bottom of the drive. Applying such pressure can either corrupt the data in the drive or damage the drive.

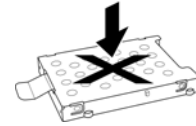

Remove the HDD (hard disk drive) according to the following procedures and Figure 4.2 and 4.3.

1. To remove the HDD, remove one M2.5x6 HDD door screw that secures the HDD and then remove the HDD door.

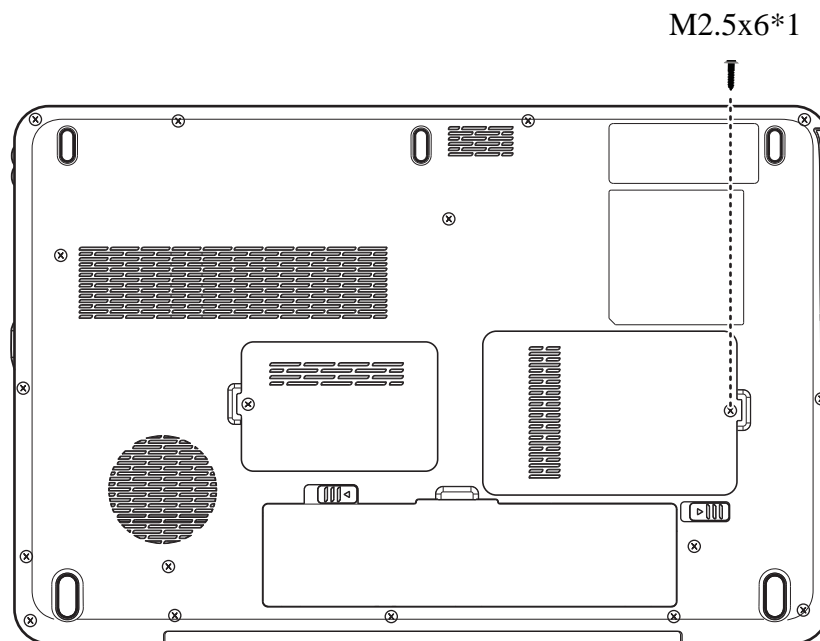

Figure 4.2 Removing the HDD door

2. Remove the HDD pack by pulling on the tab attached to the pack.

NOTE: Do not disassemble the HDD pack when it is working normally. Disassemble or replace the HDD pack only if it fails.

4 Replacement Procedures Fehler! Verwenden Sie die Registerkarte 'Start', um 標題 2 dem Text zuzuweisen, der hier angezeigt werden soll. Fehler! Verwenden Sie die Registerkarte 'Start', um 標題 2 dem Text zuzuweisen, der hier angezeigt werden soll.

3. Place the HDD pack on a flat surface such as a desk.

Fehler! Verwenden Sie die Registerkarte 'Start', um 標題 2 dem Text zuzuweisen, der hier angezeigt werden soll. Fehler! Verwenden Sie die Registerkarte 'Start', um 標題 2 dem Text zuzuweisen, der hier angezeigt werden soll.

4 Replacement Procedures

4. To separate the plate from the HDD, remove four M3x3 screws.

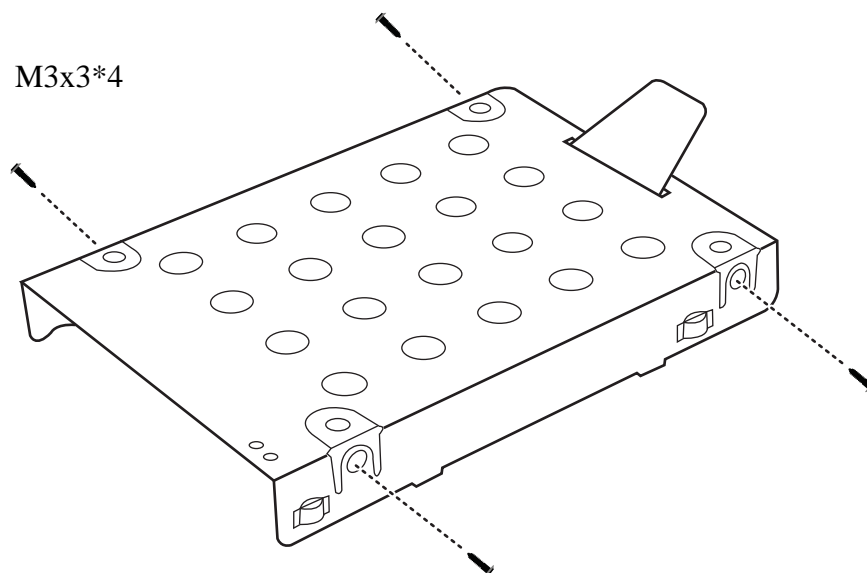

Figure 4.3 Removing the HDD plate

CAUTION: Do not apply pressure to the top or bottom of the drive.

Installing the HDD

Install the HDD according to the following procedures.

CAUTION: To avoid damage, always hold the HDD only by its sides.

1. Place the HDD into the HDD plate.
2. Secure the HDD and its plate with four M3x3 screws.

CAUTION: To prevent the HDD plate from being distorted when installing the HDD pack into the laptop, do not press the center of the HDD pack. Always hold the HDD pack by its sides.

4 Replacement Procedures Fehler! Verwenden Sie die Registerkarte 'Start', um 標題 2 dem Text zuzuweisen, der hier angezeigt werden soll. Fehler! Verwenden Sie die Registerkarte 'Start', um 標題 2 dem Text zuzuweisen, der hier angezeigt werden soll.

3. Install the HDD pack into the correct position in the laptop. Connect the HDD pack to the laptop.
4. Secure the main HDD door by tightening one M2.5x6 screw.

Fehler! Verwenden Sie die Registerkarte 'Start', um 標題 2 dem Text zuzuweisen, der hier angezeigt werden soll. Fehler! Verwenden Sie die Registerkarte 'Start', um 標題 2 dem Text zuzuweisen, der hier angezeigt werden soll.

4 Replacement Procedures

4.4 Memory

Removing the Optional Memory

Remove the optional memory according to the following procedures and Figure 4.4 and 4.5 after checking that the laptop is turned off.

CAUTION: Remove the optional memory after turning off the laptop. If this is violated, the laptop or memory can be damaged.

1. Turn the laptop upside down.
2. Release one M2.5x5 fixed screw that secures the RAM door.
3. Remove the RAM door.

CAUTION: Do not touch the connectors on the memory or in the laptop. Contaminated connectors can cause memory access problems.

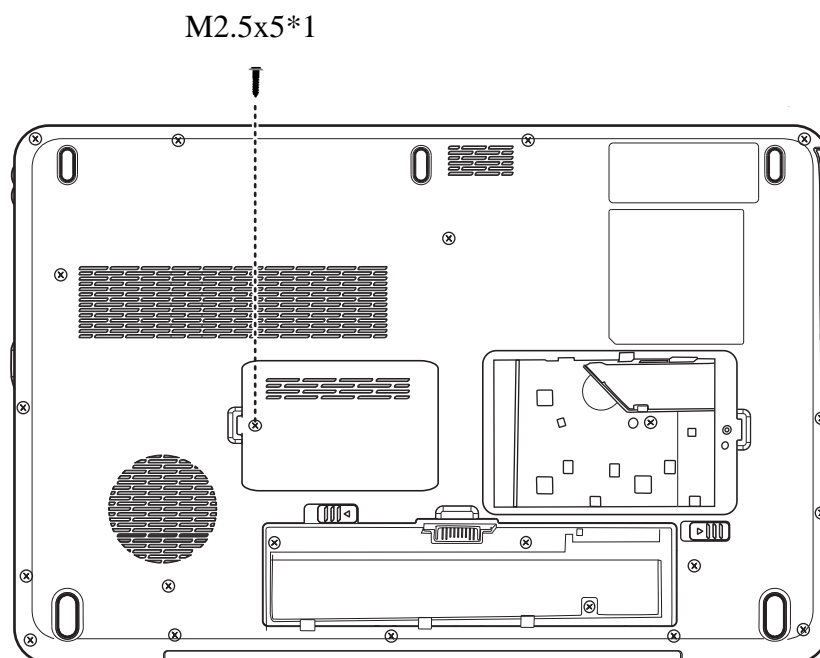

Figure 4.4 Removing the RAM door

4 Replacement Procedures Fehler! Verwenden Sie die Registerkarte 'Start', um 標題 2 dem Text zuzuweisen, der hier angezeigt werden soll. Fehler! Verwenden Sie die Registerkarte 'Start', um 標題 2 dem Text zuzuweisen, der hier angezeigt werden soll.

4. Spread out the two memory lock latches so that the memory pops up.

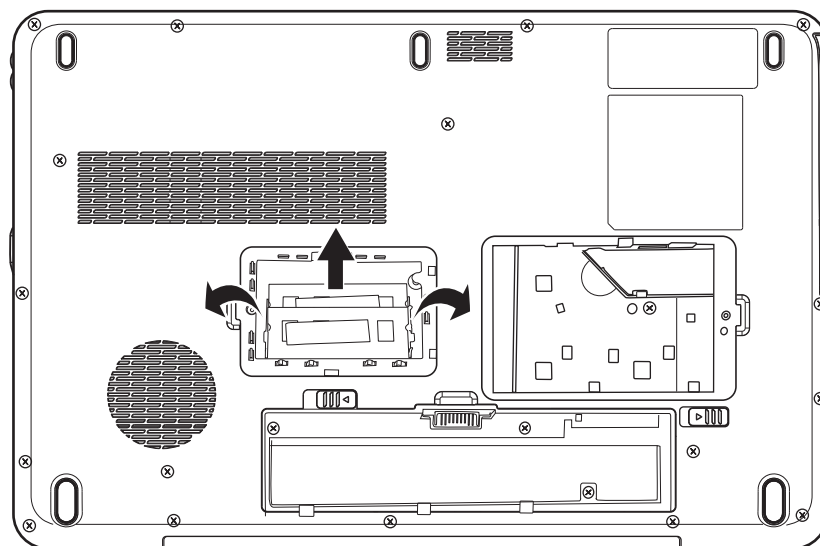

Figure 4.5 Removing the RAM from the laptop

5. Pull the memory up and out at an angle, using care to avoid touching the connectors.

Installing the Optional Memory

Install the optional memory according to the following procedures after checking that the laptop is turned off.

CAUTION: Install the optional memory after turning off the laptop. If this is violated, the laptop or memory can be damaged.

1. Insert the memory into the connector at an angle of 45 degrees.
2. Press down on the memory module so that it is secured with both memory lock latches.
3. Reinstall the optional RAM door.
4. Secure the RAM door with one M2.5x5 screw.

After the laptop is turned on, check the hardware configuration in the Hardware Setup or TESTUP program to make sure that the installed memory has been recognized by the system. If it has not been recognized yet, check the connections.

Fehler! Verwenden Sie die Registerkarte 'Start', um 標題 2 dem Text zuzuweisen, der hier angezeigt werden soll. Fehler! Verwenden Sie die Registerkarte 'Start', um 標題 2 dem Text zuzuweisen, der hier angezeigt werden soll.

4 Replacement Procedures

4.5 ODD

Removing the ODD Bay Module

NOTE: The installation and removal procedures are the same for all the modules that can be installed in the ODD bay. See the appropriate sections for the disassembly procedures of specific modules.

Remove the ODD bay module according to the following procedures and Figure 4.6.

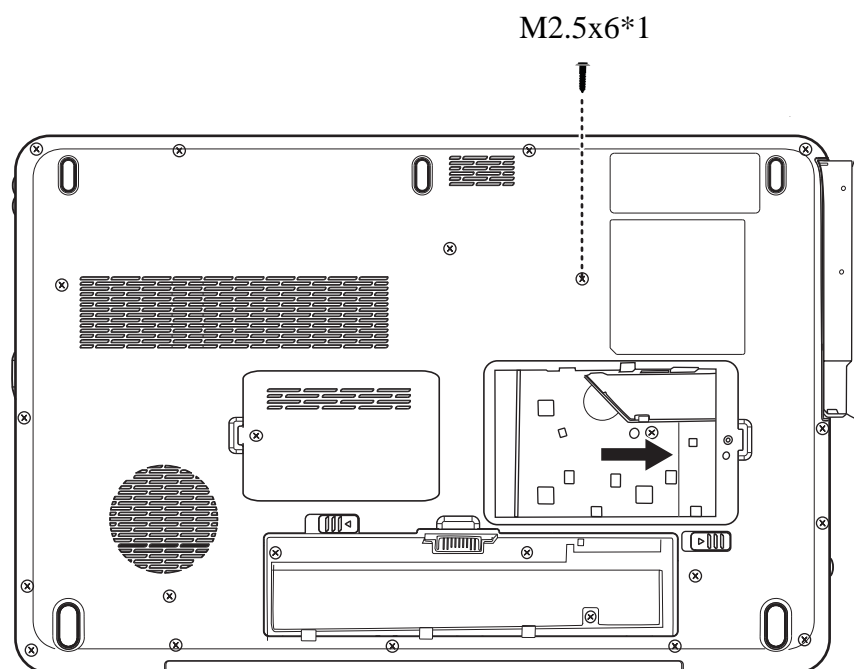

Figure 4.6 Removing the ODD Bay module

1. Turn the laptop upside down.
2. Remove one M2.5x6 screw.
3. Push the ODD bracket in the direction of the arrow.

CAUTION: Handle the ODD bay module carefully it can become hot during operation.

4 Replacement Procedures Fehler! Verwenden Sie die Registerkarte 'Start', um 標題 2 dem Text zuzuweisen, der hier angezeigt werden soll. Fehler! Verwenden Sie die Registerkarte 'Start', um 標題 2 dem Text zuzuweisen, der hier angezeigt werden soll.

Installing the ODD Bay Module

Install the ODD bay module according to the following procedures.

1. Place the ODD bay module in the correct position and slide it in.
2. Push it in until it meets the end.
3. Secure the ODD bay module with one M2.5x6 screw.

Disassembling the ODD Drive

NOTE: Do not disassemble the ODD drive when it is working normally. Disassemble or replace the ODD drive only if it fails.

Disassemble the ODD drive according to the following procedures and Figure 4.7.

1. Remove two M2x3 screws.
2. Remove the bracket.

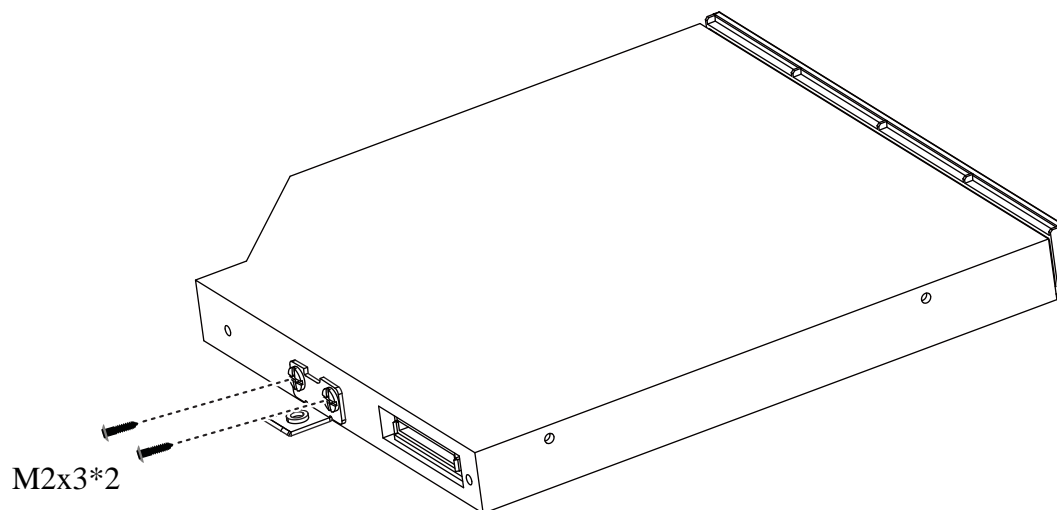

Figure 4.7 Removing the bracket from the ODD drive

Fehler! Verwenden Sie die Registerkarte 'Start', um 標題 2 dem Text zuzuweisen, der hier angezeigt werden soll. Fehler! Verwenden Sie die Registerkarte 'Start', um 標題 2 dem Text zuzuweisen, der hier angezeigt werden soll.

4 Replacement Procedures

Assembling the ODD Drive

Assemble the ODD drive according to the following procedures.

1. Seat the bracket in the correct position.
2. Secure them with two M2x3 screws.

4 Replacement Procedures Fehler! Verwenden Sie die Registerkarte 'Start', um 標題 2 dem Text zuzuweisen, der hier angezeigt werden soll. Fehler! Verwenden Sie die Registerkarte 'Start', um 標題 2 dem Text zuzuweisen, der hier angezeigt werden soll.

4.6 Keyboard Cover and Keyboard

Removing the Keyboard Cover and Keyboard

Remove the Keyboard Cover and Keyboard according to the following procedures and Figure 4.8, 4.9, 4.10.

1. Use a flat head screwdriver and position it under the keyboard cover above the Scroll Lock key. Apply leverage and lift the keyboard cover from the laptop.
2. Remove the keyboard cover.



Figure 4.8 Removing the keyboard cover

Fehler! Verwenden Sie die Registerkarte 'Start', um 標題 2 dem Text zuzuweisen, der hier angezeigt werden soll. Fehler! Verwenden Sie die Registerkarte 'Start', um 標題 2 dem Text zuzuweisen, der hier angezeigt werden soll.

4 Replacement Procedures

3. Remove two M2.5x4 screws and unhook three tabs from the top of the keyboard.

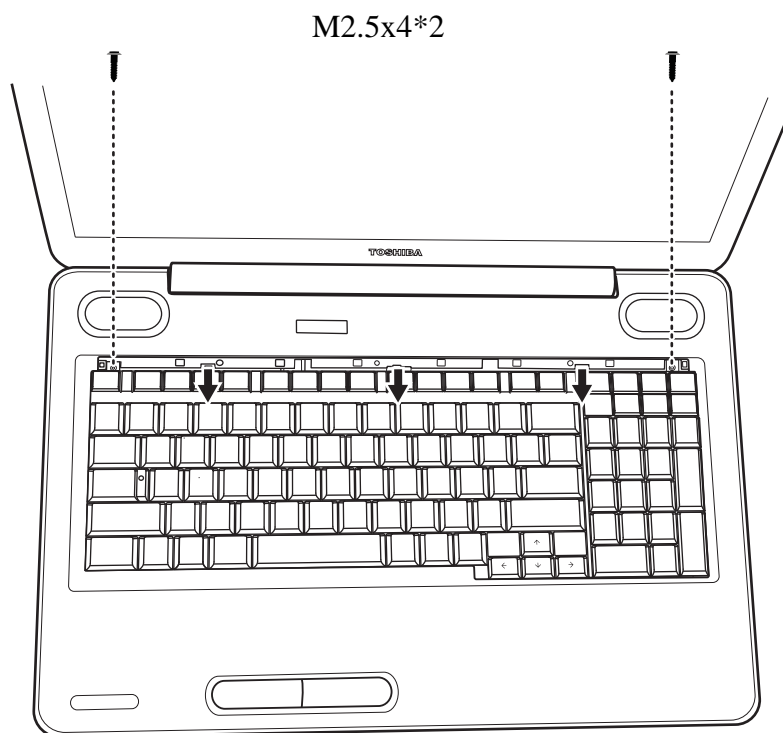

Figure 4.9 Removing screws and releasing hooks from the keyboard

4. Lift the keyboard up and detach the cable on the back of the keyboard from the motherboard.

4 Replacement Procedures Fehler! Verwenden Sie die Registerkarte 'Start', um 標題 2 dem Text zuzuweisen, der hier angezeigt werden soll. Fehler! Verwenden Sie die Registerkarte 'Start', um 標題 2 dem Text zuzuweisen, der hier angezeigt werden soll.

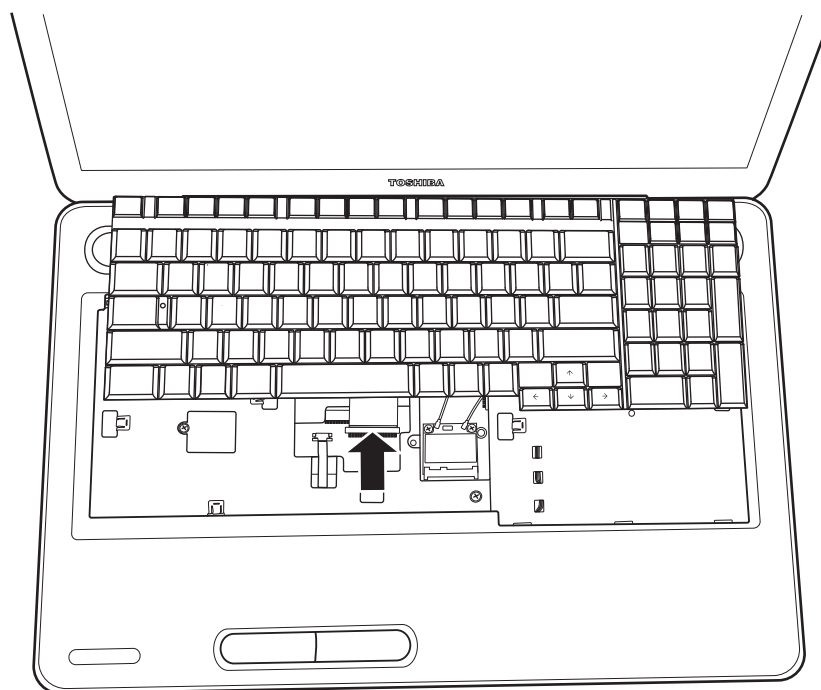

Figure 4.10 Removing the keyboard

Installing the keyboard Cover and Keyboard

Install the keyboard cover and keyboard according to the following procedures.

1. Attach the cable on the back of the keyboard to the motherboard and place the keyboard in the correct position.
2. Secure the keyboard with two M2.5x4 screws and click into place three tabs at the top of the keyboard.
3. Place the keyboard cover in the correct position, then press the cover down from the middle to the left side, making sure the hooks on the back of the cover are securely in the laptop.
4. Press down the cover on the right side to make sure the hooks on the back of the cover are firmly in the laptop.
5. Press down the cover in the position around the key F9 and slide to the side to make sure the last hook on the back of the cover is placed firmly in the laptop.

Fehler! Verwenden Sie die Registerkarte 'Start', um 標題 2 dem Text zuzuweisen, der hier angezeigt werden soll. Fehler! Verwenden Sie die Registerkarte 'Start', um 標題 2 dem Text zuzuweisen, der hier angezeigt werden soll.

4.7 Logic Upper Assembly

Removing the Logic Upper Assembly

Remove the logic upper assembly according to the following procedures and Figure 4.11, 4.12 and 4.13.

1. Turn the laptop upside down and remove the following 21 screws:
 - Seventeen M2.5x6 screws
 - Four M2.5x4 screws

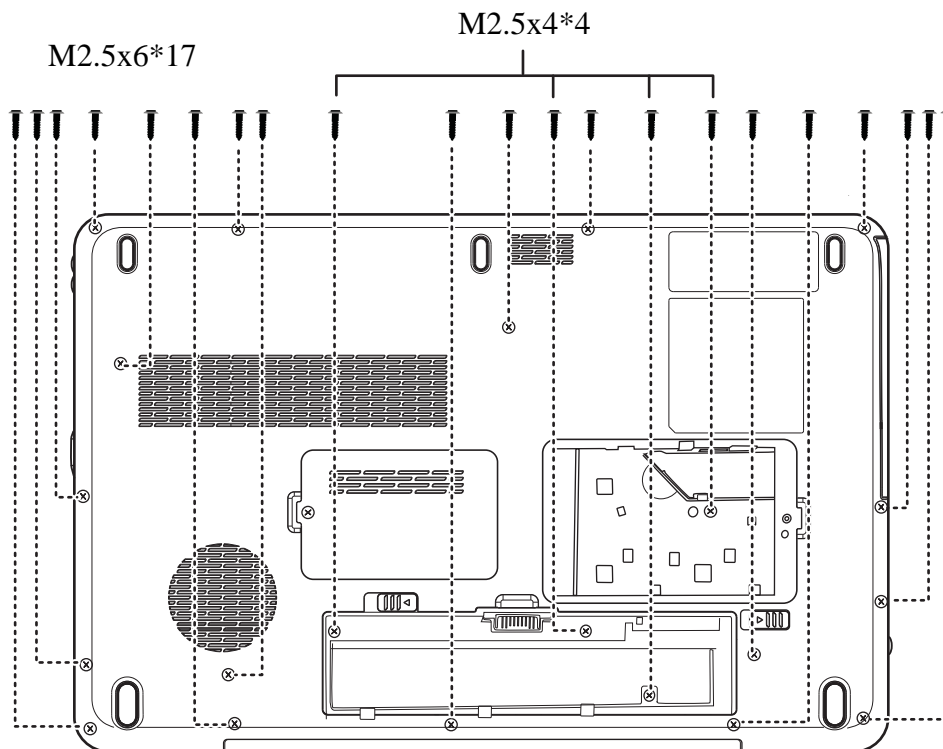

Figure 4.11 Removing the screws from the bottom of the laptop

4 Replacement Procedures Fehler! Verwenden Sie die Registerkarte 'Start', um 標題 2 dem Text zuzuweisen, der hier angezeigt werden soll. Fehler! Verwenden Sie die Registerkarte 'Start', um 標題 2 dem Text zuzuweisen, der hier angezeigt werden soll.

2. Turn the laptop over and open it. Remove six 2.5x6 screws.

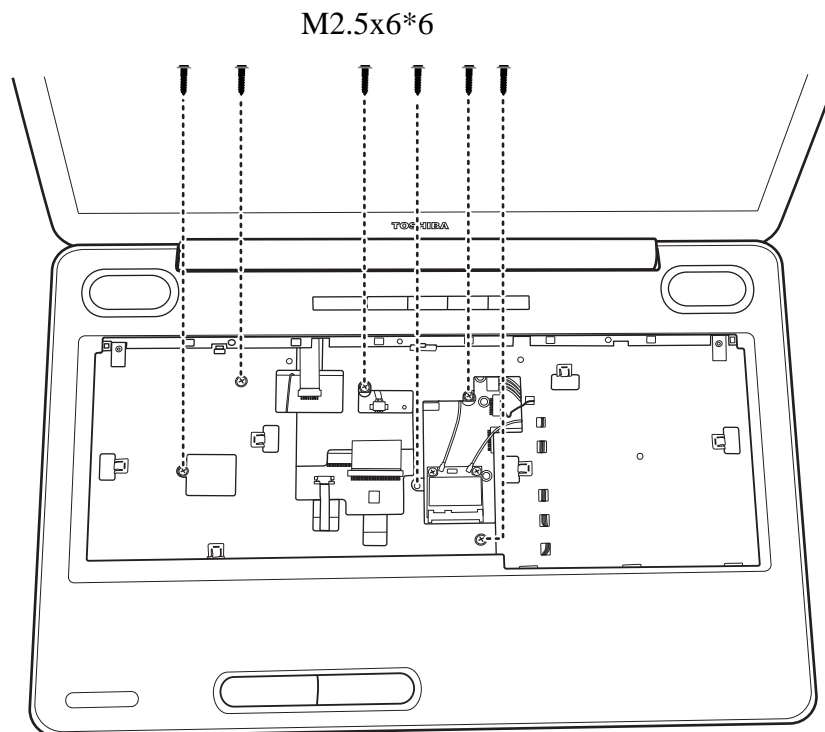

Figure 4.12 Removing six screws from under the keyboard.

Fehler! Verwenden Sie die Registerkarte 'Start', um 標題 2 dem Text zuzuweisen, der hier angezeigt werden soll. Fehler! Verwenden Sie die Registerkarte 'Start', um 標題 2 dem Text zuzuweisen, der hier angezeigt werden soll.

4 Replacement Procedures

3. Detach one Power board FFC, one Bluetooth cable and one Touch Pad cable as shown in Figure 4.13.

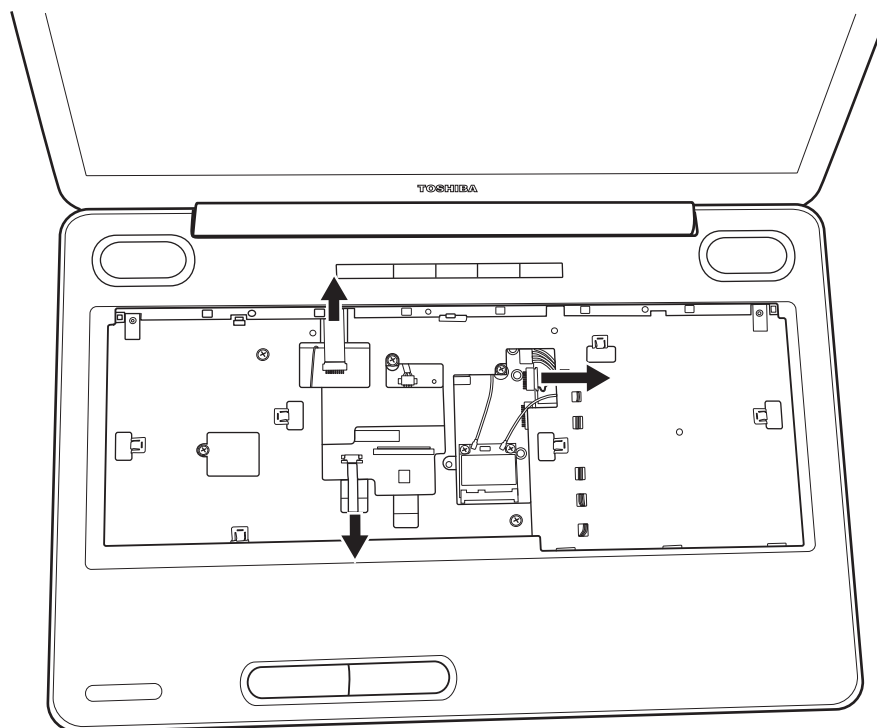

Figure 4.13 Detaching cables from under the keyboard

4. Lift up the logic upper assembly.

Installing the Logic Upper Assembly

Install the logic upper assembly according to the following procedures.

1. Seat the logic upper assembly to the front of the laptop, and adjust to the correct position.
2. Attach the three cables and secure the six screws as indicated in Figure 4.13 and 4.12.
3. Turn the laptop upside down and secure it with 21 screws as indicated in Figure 4.11:
 - Seventeen M2.5x6 screws
 - Four M2.5x4 screws

4 Replacement Procedures Fehler! Verwenden Sie die Registerkarte 'Start', um 標題 2 dem Text zuzuweisen, der hier angezeigt werden soll. Fehler! Verwenden Sie die Registerkarte 'Start', um 標題 2 dem Text zuzuweisen, der hier angezeigt werden soll.

4.8 Function Board

Removing the Function Board

Remove the function board according to the following procedures and Figure 4.14.

1. Remove one M2x3 screw from the function board.
2. Separate the function board from the logic upper assembly.

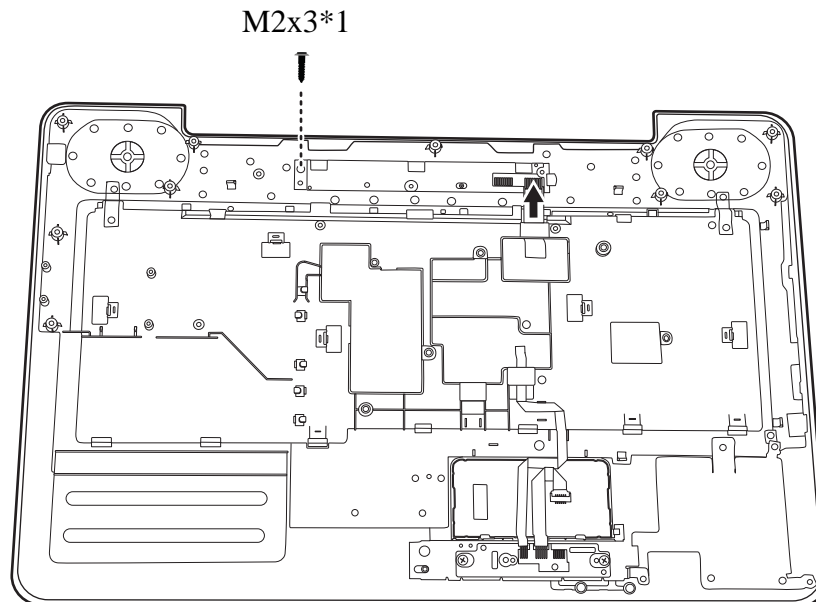

Figure 4.14 Removing the function board

Installing the function board

Install the function board according to the following procedures.

1. Seat the function board in the correct place on the logic upper assembly.
2. Secure the function board with one M2x3 screw.

Fehler! Verwenden Sie die Registerkarte 'Start', um 標題 2 dem Text zuzuweisen, der hier angezeigt werden soll. Fehler! Verwenden Sie die Registerkarte 'Start', um 標題 2 dem Text zuzuweisen, der hier angezeigt werden soll.

4 Replacement Procedures

4.9 Bluetooth Card

Removing the Bluetooth card

Remove the Bluetooth card according to the following procedures and Figure 4.15.

1. Remove the Bluetooth cable out from under the hooks on the logic upper assembly.
2. Press down the release latch and push the Bluetooth card in the direction indicated in figure 4.15, sliding the Bluetooth card out.
3. Remove the card from the logic upper assembly.

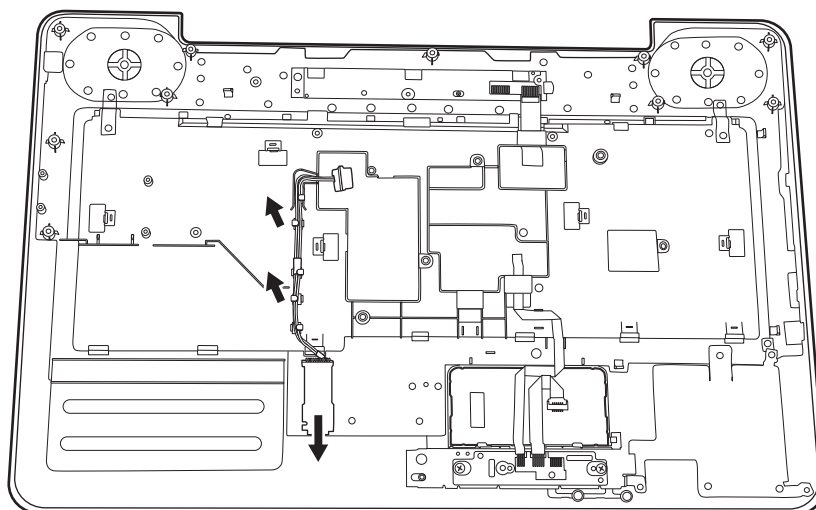

Figure 4.15 Removing the Bluetooth card

Note: Be careful not to damage the Bluetooth Card when connecting it with the cable. Make sure the card is seated in the correct position.

4 Replacement Procedures Fehler! Verwenden Sie die Registerkarte 'Start', um 標題 2 dem Text zuzuweisen, der hier angezeigt werden soll. Fehler! Verwenden Sie die Registerkarte 'Start', um 標題 2 dem Text zuzuweisen, der hier angezeigt werden soll.

Installing the Bluetooth card

Install the Bluetooth card according to the following procedures.

1. Seat the card in the correct position on the logic upper assembly.
2. Slide the card to the end of the track until the release latch clicks..
3. Secure the Bluetooth cable under the tabs on the logic upper assembly.

Fehler! Verwenden Sie die Registerkarte 'Start', um 標題 2 dem Text zuzuweisen, der hier angezeigt werden soll. Fehler! Verwenden Sie die Registerkarte 'Start', um 標題 2 dem Text zuzuweisen, der hier angezeigt werden soll.

4.10 Touch Pad Button Board and Bracket

Removing the touch pad button board and bracket

Remove the touch pad button board and bracket according to the following procedures and Figure 4.16, 4.17.

1. Remove two M2.5x4 screws and one cable from the touch pad button board.

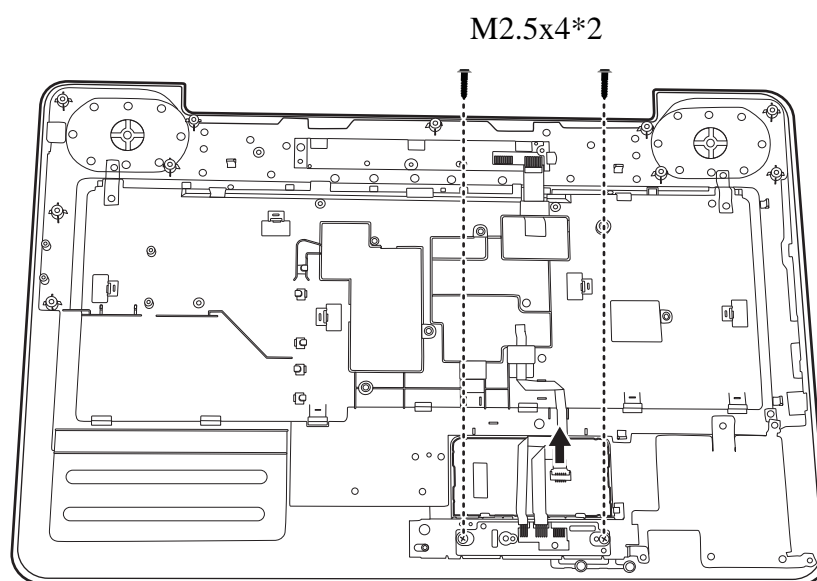

Figure 4.16 Removing the screws from the touch pad button board

2. Remove the touch pad button board.

4 Replacement Procedures Fehler! Verwenden Sie die Registerkarte 'Start', um 標題 2 dem Text zuzuweisen, der hier angezeigt werden soll. Fehler! Verwenden Sie die Registerkarte 'Start', um 標題 2 dem Text zuzuweisen, der hier angezeigt werden soll.

3. Remove one M2.5x4 screw from the touch pad bracket.

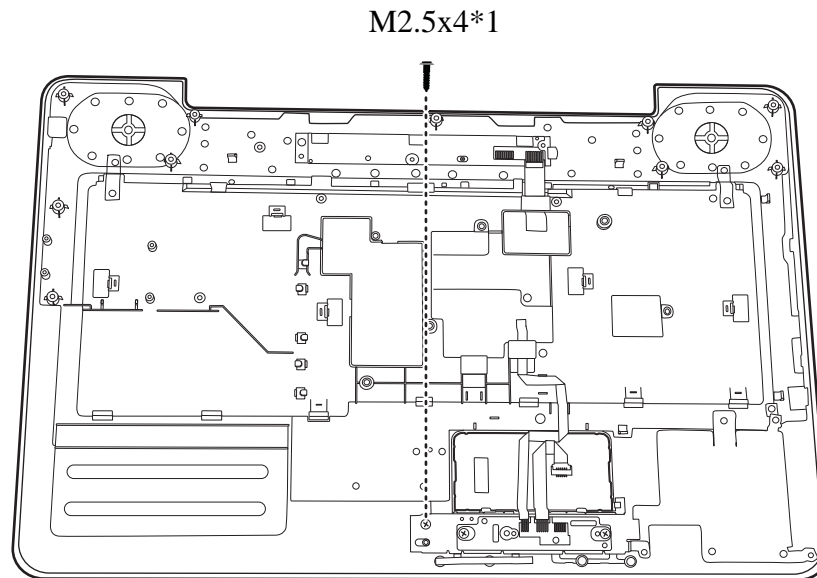

Figure 4.17 Removing the touch pad bracket

4. Remove the touch pad bracket.

Installing the Touch Pad Button board and Bracket

Install the touch pad button board and bracket according to the following procedures.

1. Seat the touch pad bracket in the correct position, then secure the bracket with one M2.5x4 screw.
2. Seat the touch pad button board over the touch pad bracket, then secure the board with two M2.5x4 screws.

Fehler! Verwenden Sie die Registerkarte 'Start', um 標題 2 dem Text zuzuweisen, der hier angezeigt werden soll. Fehler! Verwenden Sie die Registerkarte 'Start', um 標題 2 dem Text zuzuweisen, der hier angezeigt werden soll.

4.11 Speakers

Removing the Speakers

Remove the Speakers according to the following procedures and Figure 4.18.

1. Press the speaker and then remove four speaker screws from the left and right speaker.
2. Detach the speaker cable from the motherboard.
3. Remove the left and right speakers from the logic lower assembly.

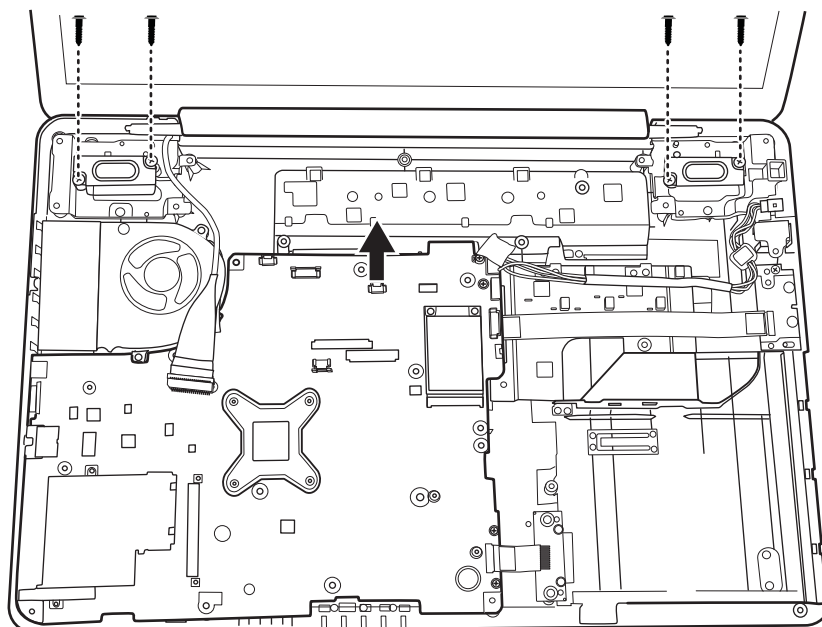

Figure 4.18 Removing the speakers

Installing the Speakers

Install the speakers according to the following procedures.

1. Seat the left and right speaker in the correct position.
2. Press speakers and secure the speakers with four speaker screws.

4 Replacement Procedures Fehler! Verwenden Sie die Registerkarte 'Start', um 標題 2 dem Text zuzuweisen, der hier angezeigt werden soll. Fehler! Verwenden Sie die Registerkarte 'Start', um 標題 2 dem Text zuzuweisen, der hier angezeigt werden soll.

3. Attach the speaker cable to the motherboard.

Fehler! Verwenden Sie die Registerkarte 'Start', um 標題 2 dem Text zuzuweisen, der hier angezeigt werden soll. Fehler! Verwenden Sie die Registerkarte 'Start', um 標題 2 dem Text zuzuweisen, der hier angezeigt werden soll.

4 Replacement Procedures

4.12 Display Assembly

Removing the Display Assembly

CAUTION: Use care to avoid the antenna cable being caught between the display assembly and the laptop.

Remove the display assembly according to the following procedures and Figures 4.19 and 4.20.

1. Remove four M2.5x6 screws from the left and right side which secure the display assembly to the laptop.

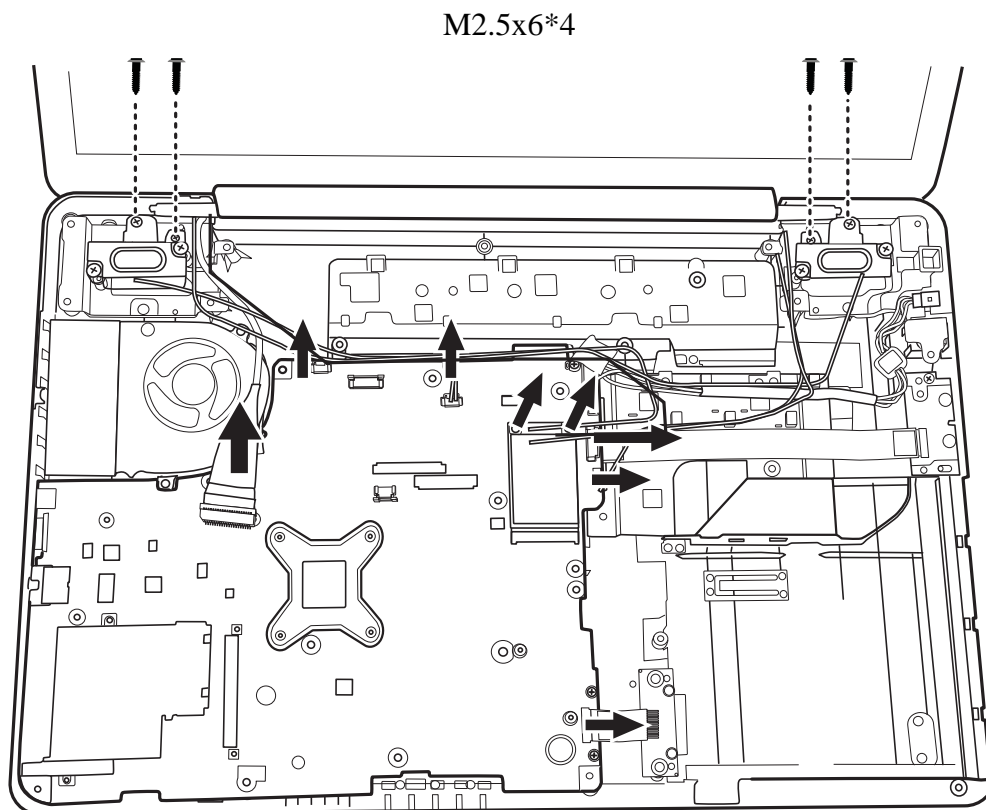

Figure 4.19 Removing the display assembly

2. Detach the following connectors from the motherboard: one LVDS cable, one fan cable, one camera cable, one microphone cable and WiFi antennas.
3. Remove the display assembly from the logic lower assembly.

4 Replacement Procedures Fehler! Verwenden Sie die Registerkarte 'Start', um 標題 2 dem Text zuzuweisen, der hier angezeigt werden soll. Fehler! Verwenden Sie die Registerkarte 'Start', um 標題 2 dem Text zuzuweisen, der hier angezeigt werden soll.

4. Remove two M2.5x4 screws that secure the hinge brackets to the logic lower assembly.

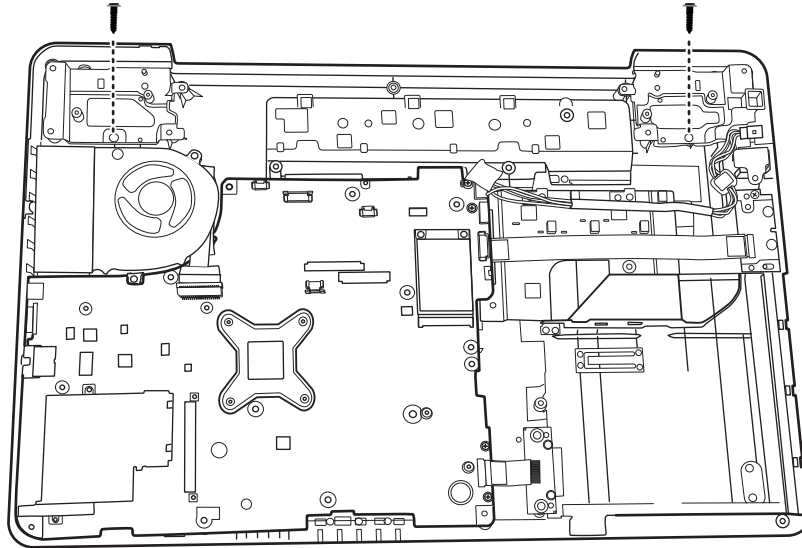

Figure 4.20 Removing the hinge brackets

5. Remove the left and right hinge brackets from the logic lower assembly.

Installing the Display Assembly

Install the display assembly according to the following procedures.

1. Place the hinge brackets in the correct position on the logic lower assembly.
2. Secure the hinge brackets with two M2.5x4 screws.
3. Place the display assembly in the correct position.
4. Secure the display assembly with four M2.5x6 screws and attach the LVDS cable to the motherboard.
5. Attach all the connectors to the motherboard as indicated in Figure 4.19.

4.13 Thermal Fan

Removing the Thermal Fan

Remove the thermal fan according to the following procedures and Figure 4.21.

1. Detach the cable from the motherboard.
2. Remove three M2.0x5 screws from the thermal fan.
3. Remove the thermal fan from the logic lower assembly.

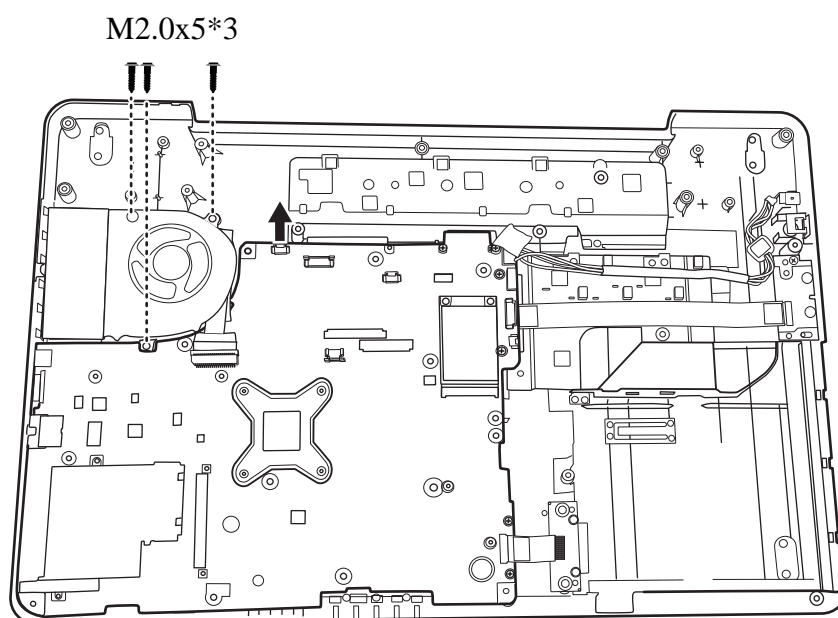

Figure 4.21 Removing the thermal fan from the logic lower assembly

Installing the Thermal Fan

Install the thermal fan according to the following procedures.

1. Seat the thermal fan in the correct position on the logic lower assembly.
2. Secure the thermal fan with three M2.0x5 screws.
3. Attach the cable to the motherboard.

4 Replacement Procedures Fehler! Verwenden Sie die Registerkarte 'Start', um 標題 2 dem Text zuzuweisen, der hier angezeigt werden soll. Fehler! Verwenden Sie die Registerkarte 'Start', um 標題 2 dem Text zuzuweisen, der hier angezeigt werden soll.

4.14 Motherboard

Removing the Motherboard

Remove the motherboard according to the following procedures.

1. Remove two M2.5x4 screws and two cables from the logic lower assembly as indicated by arrows in Figure 4.22.

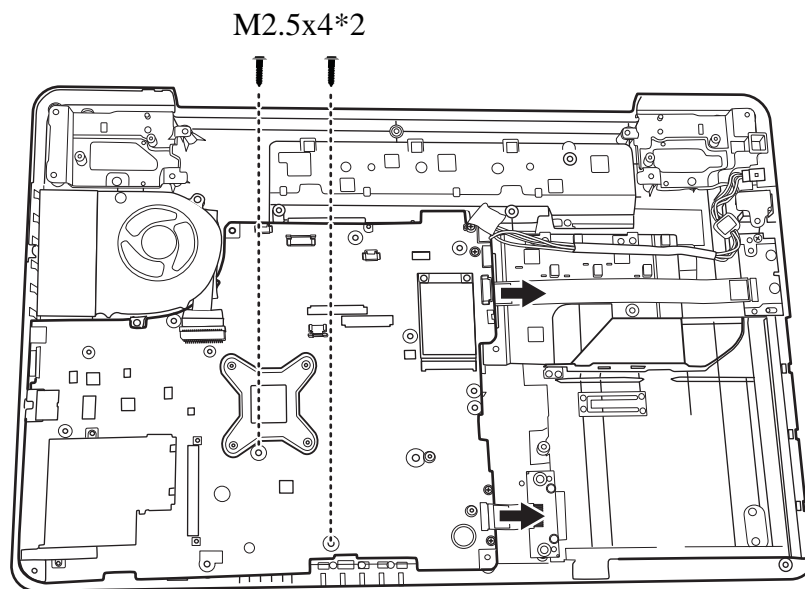

Figure 4.22 Removing the motherboard from logic lower assembly

Fehler! Verwenden Sie die Registerkarte 'Start', um 標題 2 dem Text zuzuweisen, der hier angezeigt werden soll. Fehler! Verwenden Sie die Registerkarte 'Start', um 標題 2 dem Text zuzuweisen, der hier angezeigt werden soll.

4 Replacement Procedures

2. Remove the DC IN connector and cable out of the logic lower assembly from right to left, as shown in Figure 4.23.

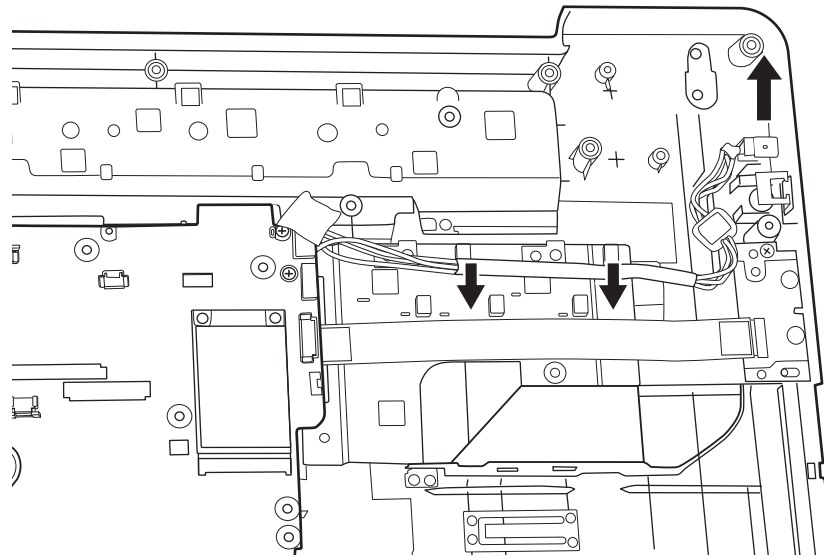

Figure 4.23 Removing the DC IN connector and cable

3. Use your hands to pick up the motherboard in the direction of the arrows as shown in figure 4.24.

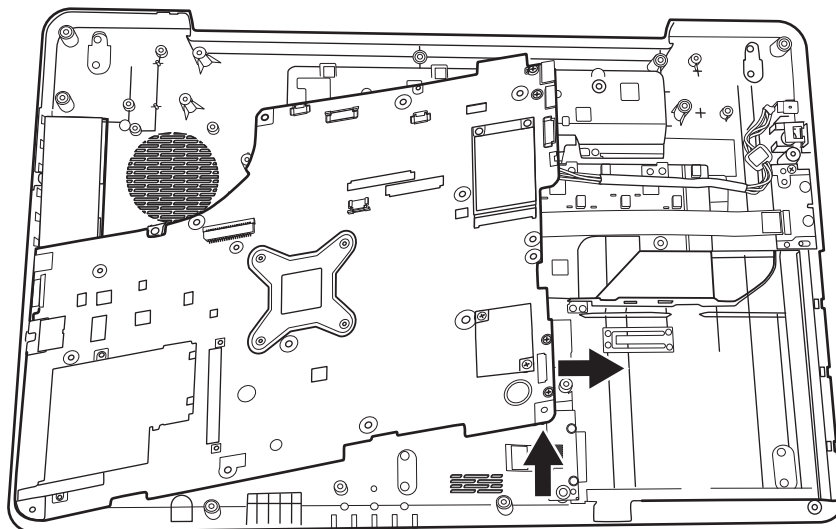

Figure 4.24 Picking up the motherboard

4 Replacement Procedures Fehler! Verwenden Sie die Registerkarte 'Start', um 標題 2 dem Text zuzuweisen, der hier angezeigt werden soll. Fehler! Verwenden Sie die Registerkarte 'Start', um 標題 2 dem Text zuzuweisen, der hier angezeigt werden soll.

4. Remove the motherboard from the logic lower assembly.

Fehler! Verwenden Sie die Registerkarte 'Start', um 標題 2 dem Text zuzuweisen, der hier angezeigt werden soll. Fehler! Verwenden Sie die Registerkarte 'Start', um 標題 2 dem Text zuzuweisen, der hier angezeigt werden soll.

4 Replacement Procedures

Installing the Motherboard

Install the motherboard according to the following procedures.

1. Before seat the motherboard on the logic lower assembly, pull out the LVDS cable and any other cables to avoid being pressed.
2. Align the connectors on the left side to their corresponding holes in the logic lower assembly as shown in Figure 4.25.

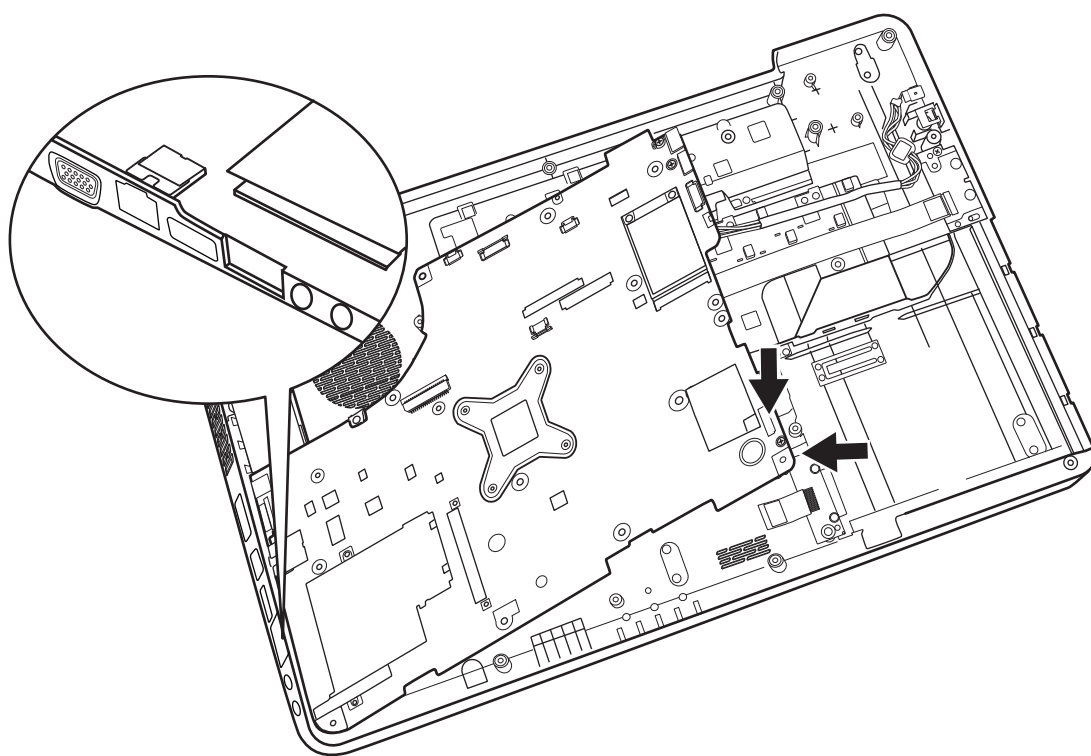

Figure 4.25 Aligning the motherboard connectors

3. Seat the motherboard down in the lower logic assembly.

4 Replacement Procedures Fehler! Verwenden Sie die Registerkarte 'Start', um 標題 2 dem Text zuzuweisen, der hier angezeigt werden soll. Fehler! Verwenden Sie die Registerkarte 'Start', um 標題 2 dem Text zuzuweisen, der hier angezeigt werden soll.

4. Put the DC IN connector in the lower DC IN trough and route the cable from left to right under the ribs as shown in Figure 4.26.

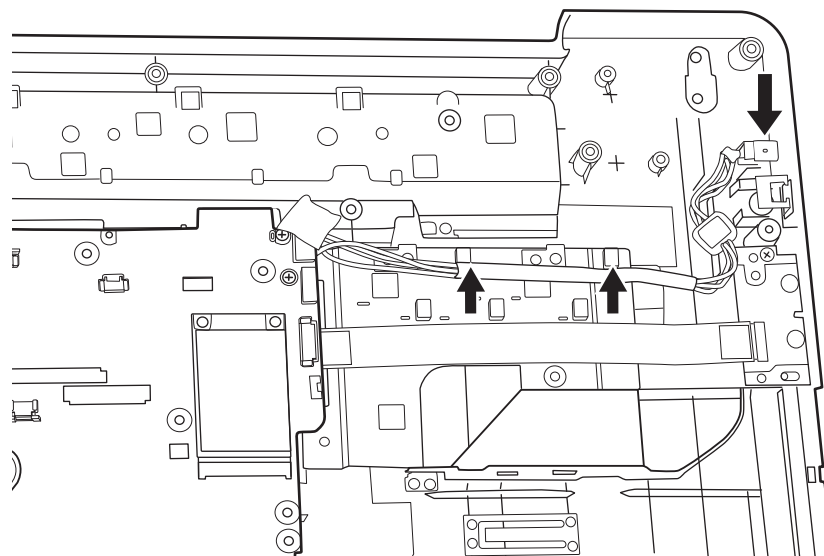

Figure 4.26 Installing the DC IN connector

5. Secure the motherboard with two M2.5x4 screws.
6. Attach two cables to the motherboard as indicated by the arrows in Figure 4.22.

Fehler! Verwenden Sie die Registerkarte 'Start', um 標題 2 dem Text zuzuweisen, der hier angezeigt werden soll. Fehler! Verwenden Sie die Registerkarte 'Start', um 標題 2 dem Text zuzuweisen, der hier angezeigt werden soll.

4 Replacement Procedures

4.15 USB Board

Removing the USB Board

Remove the USB board according to the following procedures and Figure 4.27.

1. Remove one M2.5x4 screw that secures the USB board to the logic lower assembly.
2. Detach the USB cable from the motherboard and remove the USB board from the logic lower assembly.

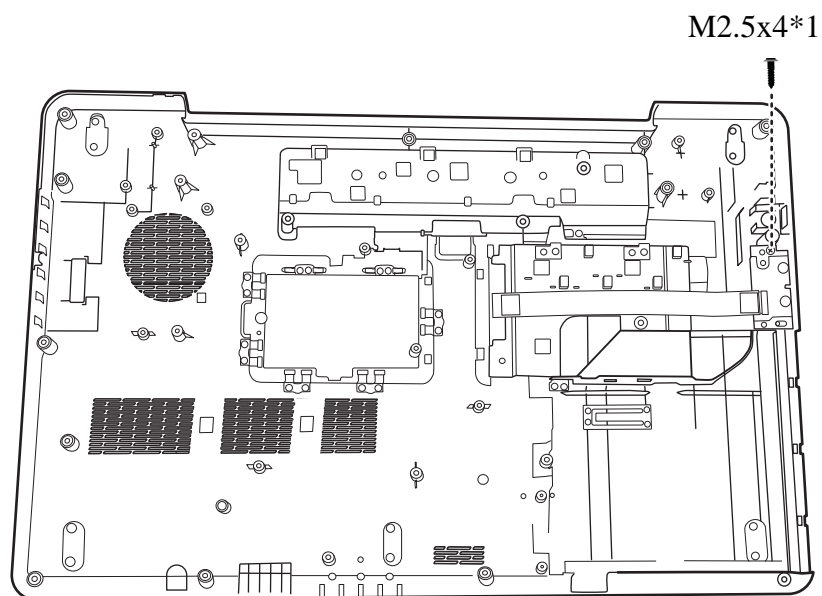

Figure 4.27 Removing the USB Board

Installing the USB Board

Install the USB board according to the following procedures.

1. Seat the USB board in the correct position on the logic lower assembly.
2. Connect the USB cable to the motherboard. Secure the USB board to the logic lower assembly with one M2.5x4 screw

4 Replacement Procedures Fehler! Verwenden Sie die Registerkarte 'Start', um 標題 2 dem Text zuzuweisen, der hier angezeigt werden soll. Fehler! Verwenden Sie die Registerkarte 'Start', um 標題 2 dem Text zuzuweisen, der hier angezeigt werden soll.

4.16 ODD Board

Removing the ODD Board

Remove the ODD board according to the following procedures and Figure 4.28.

1. Remove two M2x5 screws that secures the ODD board to the logic lower assembly.
2. Detach the ODD cable from the motherboard and remove the ODD board from the logic lower assembly.

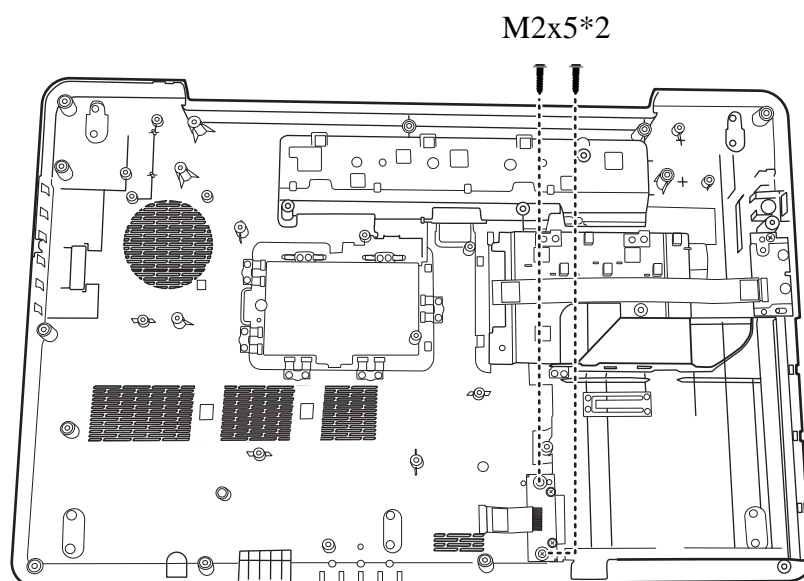

Figure 4.28 Removing the ODD Board

Installing the ODD Board

Install the ODD board according to the following procedures.

1. Seat the ODD board in the correct position on the logic lower assembly.
2. Connect the ODD cable to the motherboard. Secure the ODD board to the logic lower assembly with two M2x5 screws.

Fehler! Verwenden Sie die Registerkarte 'Start', um 標題 2 dem Text zuzuweisen, der hier angezeigt werden soll. Fehler! Verwenden Sie die Registerkarte 'Start', um 標題 2 dem Text zuzuweisen, der hier angezeigt werden soll.

4 Replacement Procedures

4.17 Thermal Module and VGA Board (Optional)

Removing the Thermal Module and VGA Board

Remove the thermal module and VGA board according to the following procedures and Figure 4.29, 4.30.

CAUTION:

When removing the thermal module and VGA board, keep the following in mind:

- 1. The unit can become very hot during operation. Be sure to let it cool down before starting the repair work.*
- 2. Use care when removing and disassembling the unit in order to avoid damage.*
- 3. If you remove the thermal module, please use soft cloth with alcohol to clean the VGA board and the thermal module. Reapply Shinetsu 7762 grease before installing the thermal module. If you use one new thermal module, please make sure to remove the release paper first.*

1. Remove six spring screws securing the thermal module to the motherboard, according to the number sequence sealed on the thermal module.
2. Remove the thermal module from the motherboard.

5 4 1 6 2 3

4 Replacement Procedures Fehler! Verwenden Sie die Registerkarte 'Start', um 標題 2 dem Text zuzuweisen, der hier angezeigt werden soll. Fehler! Verwenden Sie die Registerkarte 'Start', um 標題 2 dem Text zuzuweisen, der hier angezeigt werden soll.

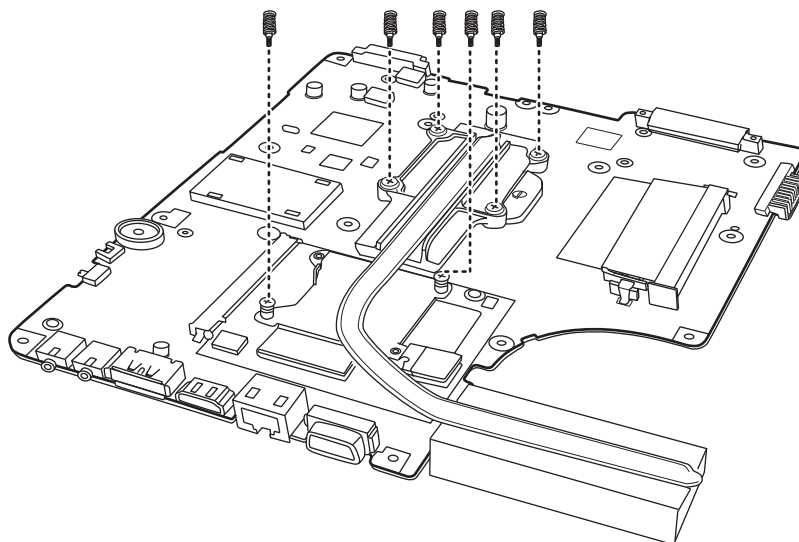

Figure 4.29 Removing the Thermal Module

3. Remove two M2.5x4 screws on the VGA board and remove the board from its slot on the motherboard.

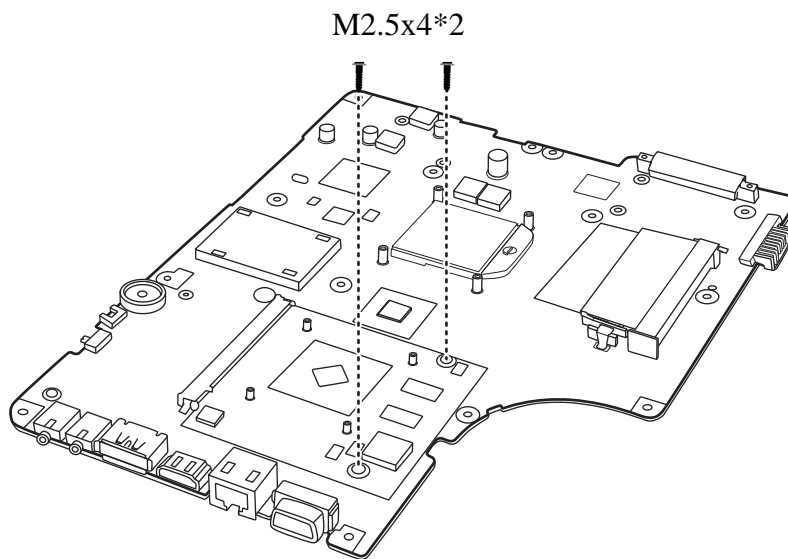

Figure 4.30 Removing the VGA Board

Installing the VGA Board and Thermal Module

Install the VGA board and Thermal Module according to the following procedures.

Fehler! Verwenden Sie die Registerkarte 'Start', um 標題 2 dem Text zuzuweisen, der hier angezeigt werden soll. Fehler! Verwenden Sie die Registerkarte 'Start', um 標題 2 dem Text zuzuweisen, der hier angezeigt werden soll.

4 Replacement Procedures

1. Reapply Shinetsu 7762 grease on the thermal module as shown in Figure 4.31. If you use a new thermal module, remove any release papers from the thermal pads first.

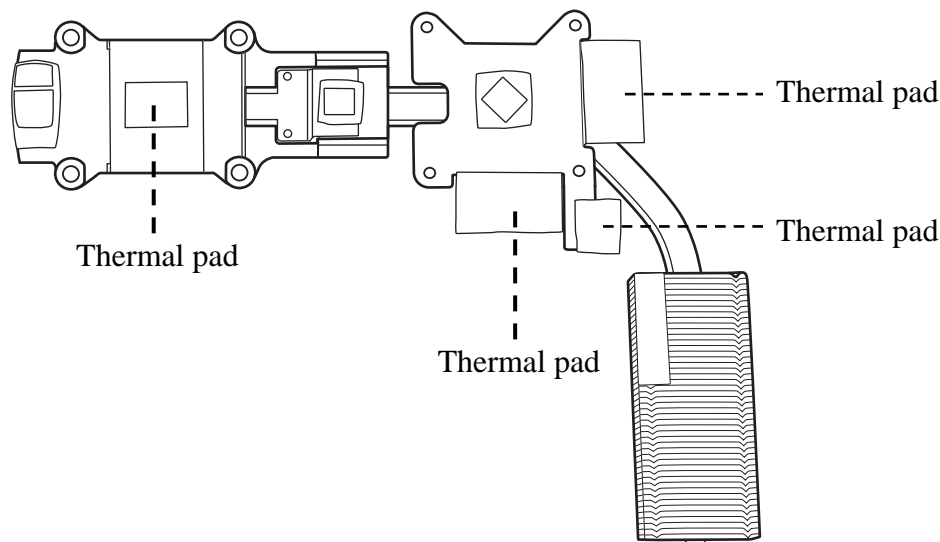

Figure 4.31 Reapply Shinetsu 7726 grease on the thermal module and remove any release papers

NOTE: When thermal pad needs to be changed, please paste it in the location indicated in Figure 4.31.

2. Seat the VGA board on the motherboard and secure it with two M2.5x4 screws.
3. Seat the thermal module in the correct position on the motherboard and secure it with six spring screws according to the number sequence sealed on the thermal module.

4 Replacement Procedures Fehler! Verwenden Sie die Registerkarte 'Start', um 標題 2 dem Text zuzuweisen, der hier angezeigt werden soll. Fehler! Verwenden Sie die Registerkarte 'Start', um 標題 2 dem Text zuzuweisen, der hier angezeigt werden soll.

4.18 CPU

Removing the CPU

Remove the CPU according to the following procedures and Figure 4.32.

CAUTION:

When removing the CPU, keep the following in mind:

The CPU can become very hot during operation. Be sure to let it cool down before starting repair work.

1. Unlock the CPU by rotating the cam on the CPU socket counterclockwise to the unlock position with a flat-blade screwdriver.

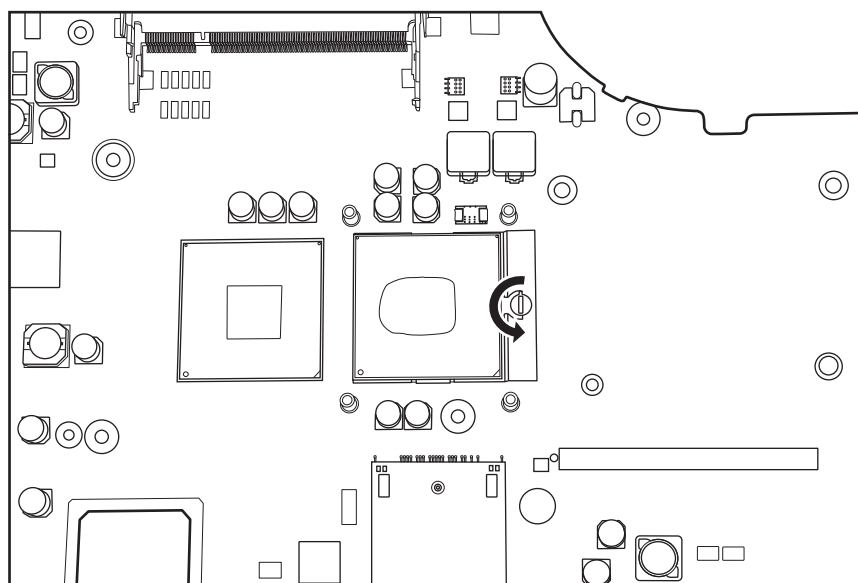

Figure 4.32 Removing the CPU

4. Remove the CPU.

Fehler! Verwenden Sie die Registerkarte 'Start', um 標題 2 dem Text zuzuweisen, der hier angezeigt werden soll. Fehler! Verwenden Sie die Registerkarte 'Start', um 標題 2 dem Text zuzuweisen, der hier angezeigt werden soll.

4 Replacement Procedures

Installing CPU

Install the CPU according to the following procedures.

1. Check the cam is in the unlock position.
2. Seat the CPU on the socket, using care not to damage the pins. Align the CPU with the CPU socket by using the triangle as a guide.
3. Rotate the cam clockwise to the lock position with a flat-blade screwdriver.

4 Replacement Procedures Fehler! Verwenden Sie die Registerkarte 'Start', um 標題 2 dem Text zuzuweisen, der hier angezeigt werden soll. Fehler! Verwenden Sie die Registerkarte 'Start', um 標題 2 dem Text zuzuweisen, der hier angezeigt werden soll.

4.19 WLAN Card

Removing the WLAN Card

Remove the WLAN card according to the following procedures and Figure 4.33.

1. Detach the two antennas on the WLAN card.
2. Remove two M2.5x4 screws that secure the WLAN card.
3. Pull the WLAN card out at an angle.

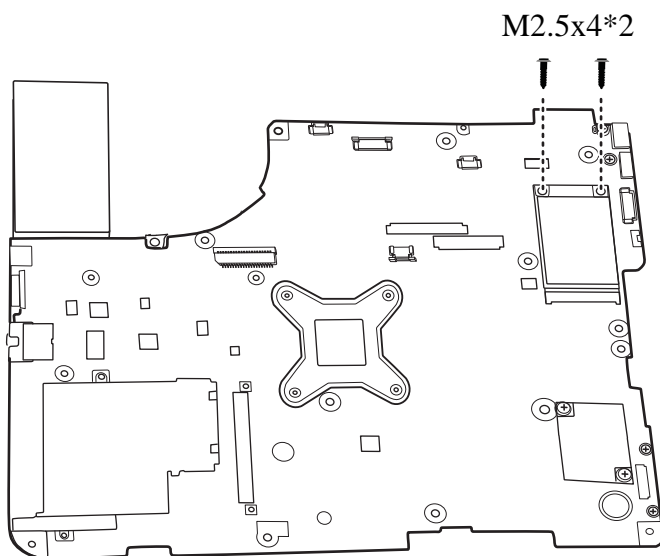

Figure 4.33 Removing the WLAN card

Installing the WLAN Card

Install the WLAN card according to the following procedures.

1. Insert the WLAN card into the connector.
2. Press the card down and secure it with two M2.5x4 screws.
3. Attach the two antennas to the WLAN card.

Fehler! Verwenden Sie die Registerkarte 'Start', um 標題 2 dem Text zuzuweisen, der hier angezeigt werden soll. Fehler! Verwenden Sie die Registerkarte 'Start', um 標題 2 dem Text zuzuweisen, der hier angezeigt werden soll.

4.20 Modem Card (Optional)

Removing the Modem Card

Remove the modem card according to the following procedures and Figure 4.34.

1. Remove two M2x3 screws that secure the modem card.
2. Flip the modem card over, and detach the cable connected to the card.

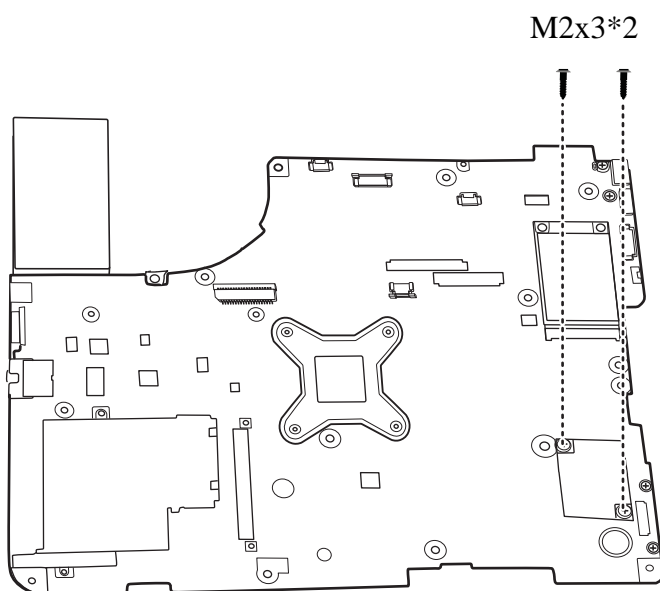

Figure 4.34 Removing the modem card

Installing the Modem Card

Install the modem card according to the following procedures.

1. Attach the cable to the back of the modem card.
2. Install the card in the correct position and secure it with two M2x3 screws.

4 Replacement Procedures Fehler! Verwenden Sie die Registerkarte 'Start', um 標題 2 dem Text zuzuweisen, der hier angezeigt werden soll. Fehler! Verwenden Sie die Registerkarte 'Start', um 標題 2 dem Text zuzuweisen, der hier angezeigt werden soll.

4.21 LCD Bezel Assembly

Removing the LCD Bezel Assembly

Remove the LCD bezel assembly according to the following procedures.

1. Remove six rubber seals from above the screws in the LCD bezel assembly.
2. Remove six M2.5x6 screws as shown in Figure 4.35.

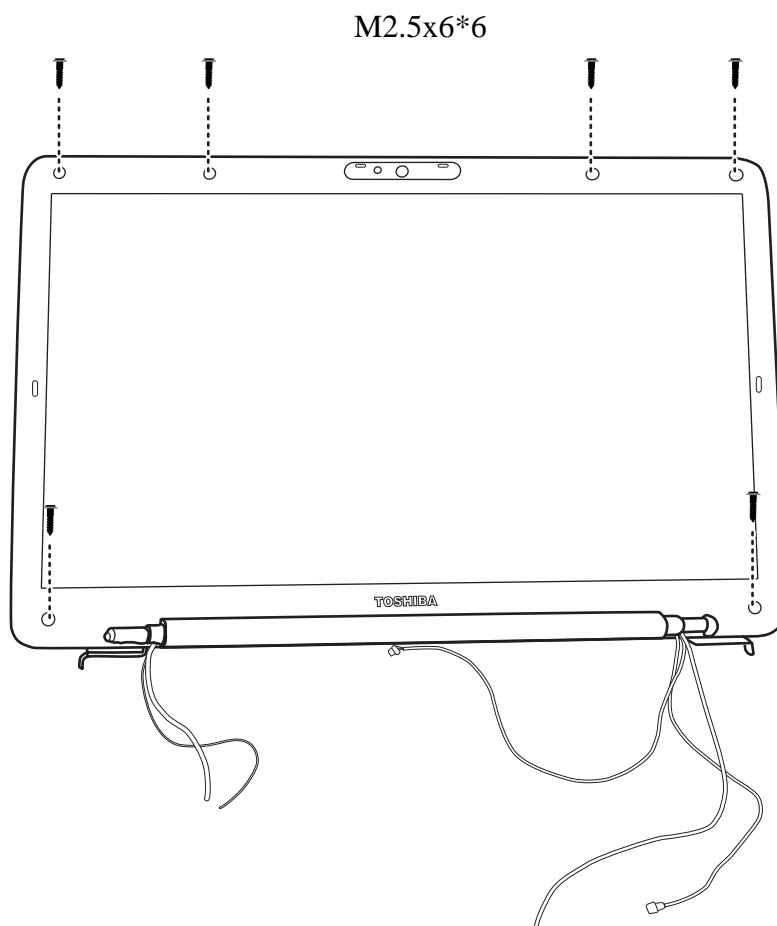

Figure 4.35 Removing the LCD Bezel Assembly

3. Take out the bezel hinge wall from the cover hinge wall as shown in Figure 4.36.

Fehler! Verwenden Sie die Registerkarte 'Start', um 標題 2 dem Text zuzuweisen, der hier angezeigt werden soll. Fehler! Verwenden Sie die Registerkarte 'Start', um 標題 2 dem Text zuzuweisen, der hier angezeigt werden soll.

4 Replacement Procedures

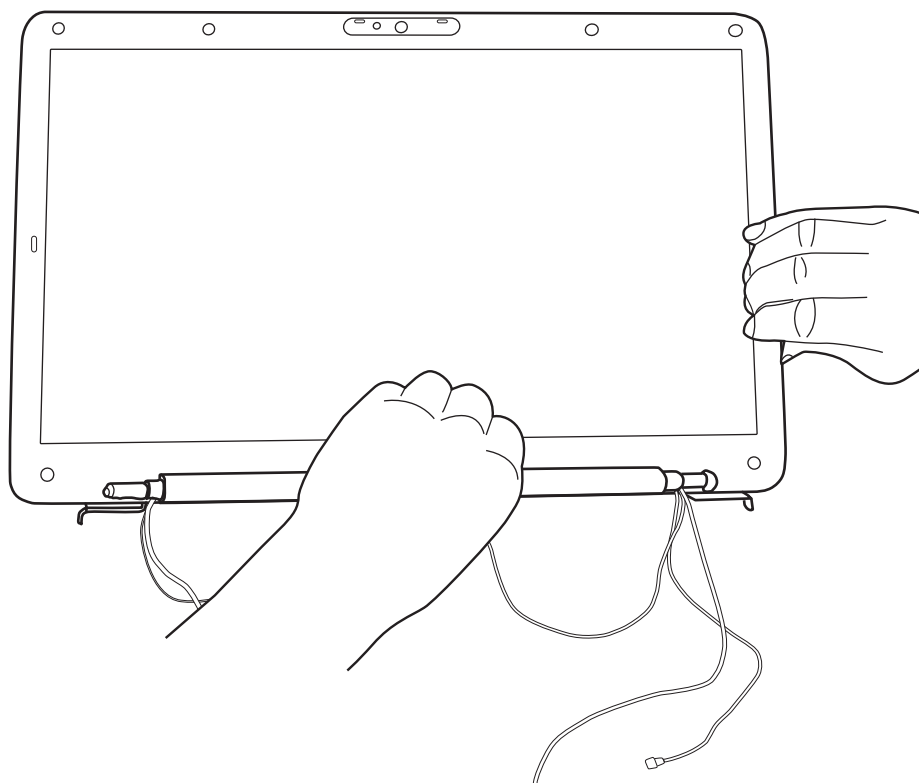

Figure 4.36 Taking out the hinge wall

4. Pull apart the lower half of the bezel; leave this portion above the left and right LCD hinge.
5. Push the bezel from the left and right side as shown in Figure 4.37 and remove the bezel from the display assembly.

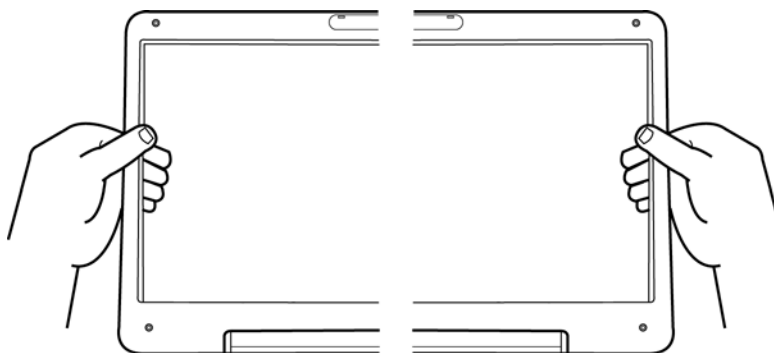

Figure 4.37 Removing the bezel from the hinge wall

4 Replacement Procedures Fehler! Verwenden Sie die Registerkarte 'Start', um 標題 2 dem Text zuzuweisen, der hier angezeigt werden soll. Fehler! Verwenden Sie die Registerkarte 'Start', um 標題 2 dem Text zuzuweisen, der hier angezeigt werden soll.

Installing the LCD bezel

Install the LCD bezel assembly according to the following procedures.

1. Reroute the LVDS and antenna cables behind the LCD hinges.

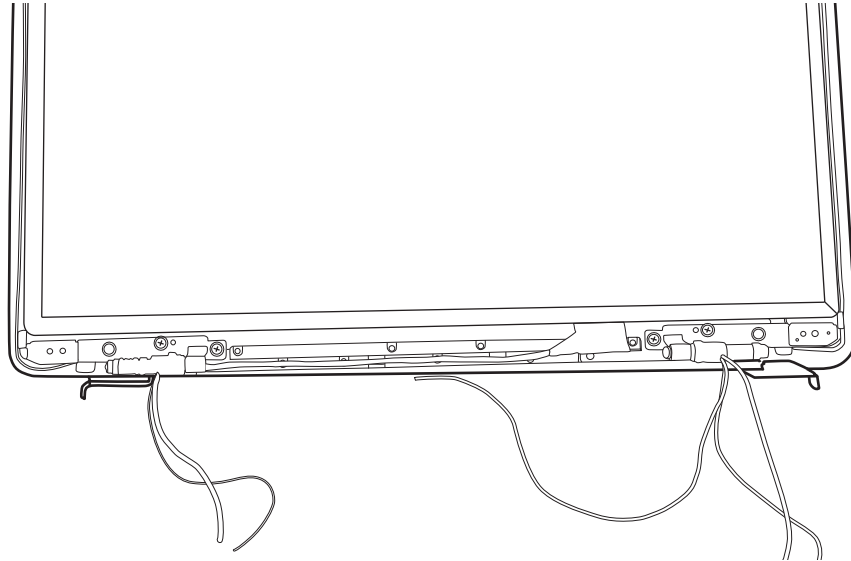

Figure 4.38 Reroute the cables

2. Seat the LCD bezel assembly in the correct position.

Fehler! Verwenden Sie die Registerkarte 'Start', um 標題 2 dem Text zuzuweisen, der hier angezeigt werden soll. Fehler! Verwenden Sie die Registerkarte 'Start', um 標題 2 dem Text zuzuweisen, der hier angezeigt werden soll.

4 Replacement Procedures

3. Press the bezel hinge wall against the cover hinge wall as shown in Figure 4.39.

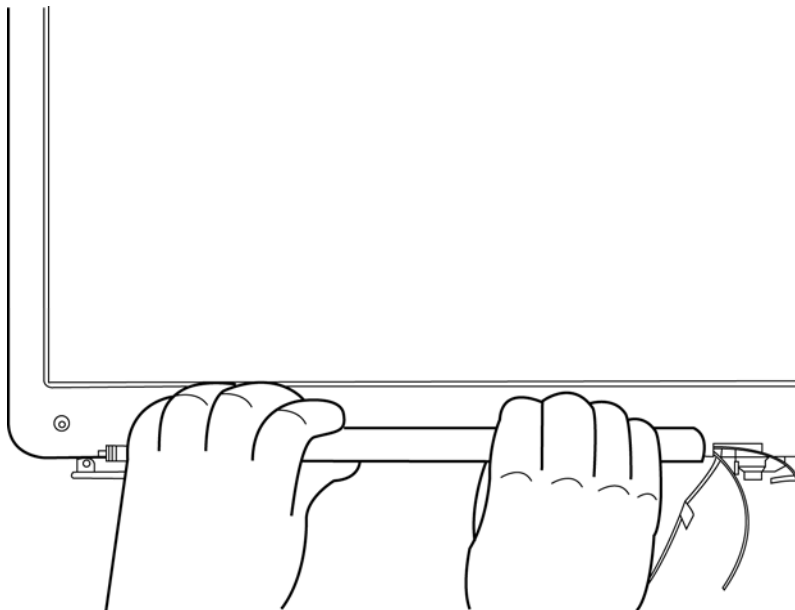

Figure 4.39 Pressing the bezel hinge wall

4. Press the bezel downside hook near the hinge wall as shown in Figure 4.40.

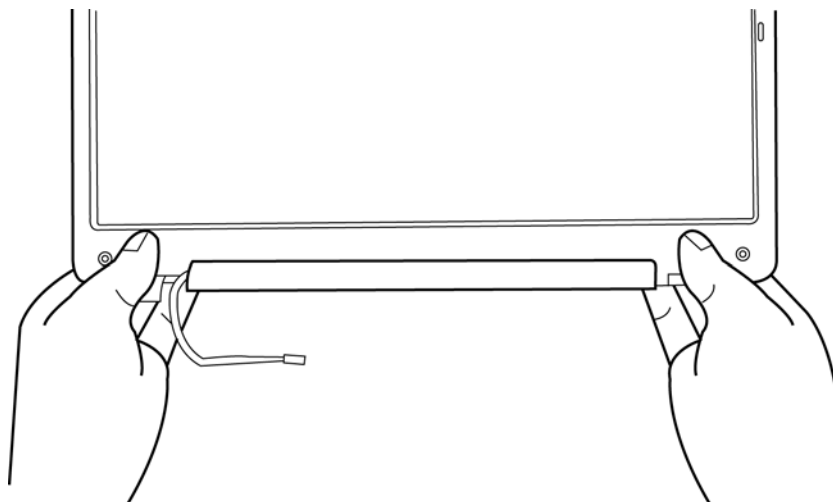

Figure 4.40 Pressing the bezel downside hook

4 Replacement Procedures Fehler! Verwenden Sie die Registerkarte 'Start', um 標題 2 dem Text zuzuweisen, der hier angezeigt werden soll. Fehler! Verwenden Sie die Registerkarte 'Start', um 標題 2 dem Text zuzuweisen, der hier angezeigt werden soll.

5. Press the left and right side of the bezel as shown in Figure 4.41.

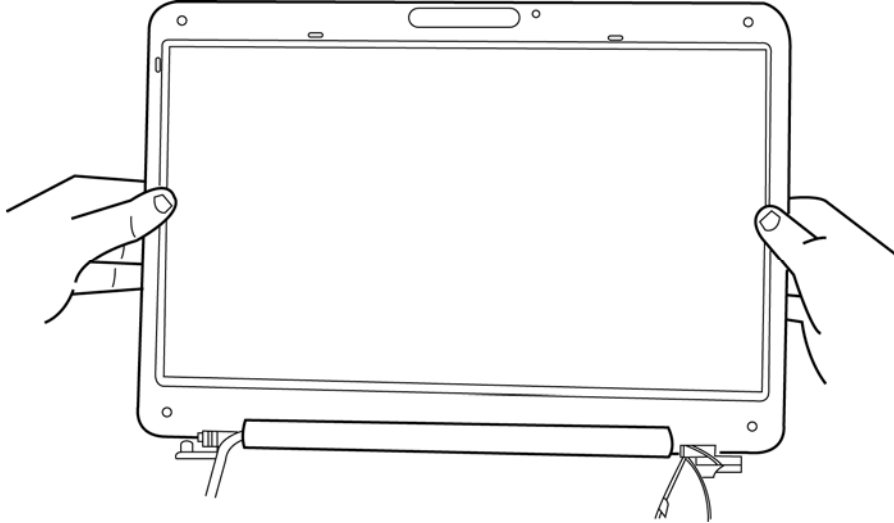

Figure 4.41 Pressing the left and right side of the bezel

6. Press the bezel upside hooks as shown in Figure 4.42.

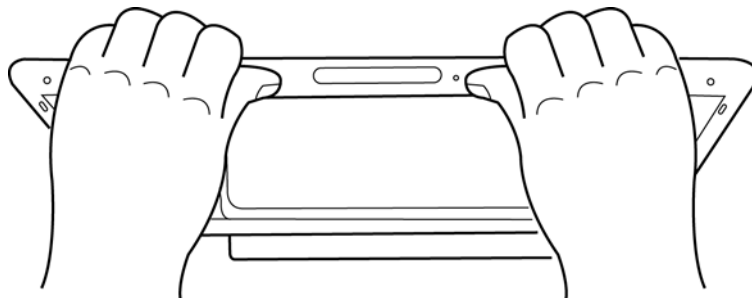

Figure 4.42 Pressing the bezel upside hooks

7. Secure it to the display assembly with six M2.5x6 screws.
8. Place six rubber seals over the screw holes.

Fehler! Verwenden Sie die Registerkarte 'Start', um 標題 2 dem Text zuzuweisen, der hier angezeigt werden soll. Fehler! Verwenden Sie die Registerkarte 'Start', um 標題 2 dem Text zuzuweisen, der hier angezeigt werden soll.

4.22 LCD Module

Removing the LCD Module

Remove the LCD module according to the following procedures and Figure 4.43, 4.44 and 4.45.

1. Remove four M2.5x6 screws securing the LCD module according to the sequence indicated in the Figure 4.43.
2. After removing the screws, remove the tape on the LCD panel, and then remove the LCD module from LCD assembly.

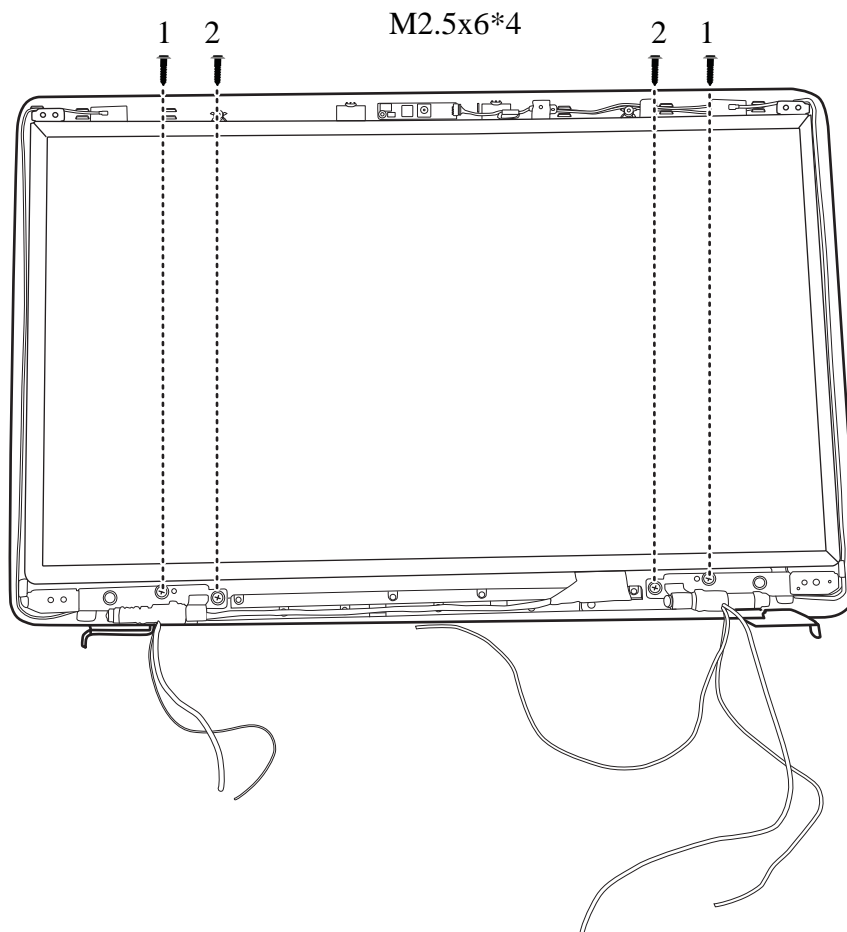

Figure 4.43 Removing the LCD Module from the LCD cover assembly

4 Replacement Procedures Fehler! Verwenden Sie die Registerkarte 'Start', um 標題 2 dem Text zuzuweisen, der hier angezeigt werden soll. Fehler! Verwenden Sie die Registerkarte 'Start', um 標題 2 dem Text zuzuweisen, der hier angezeigt werden soll.

3. Remove six M2x2.5 screws according to the sequence indicated in the Figure 4.44, and then remove the LCD hinge assembly.

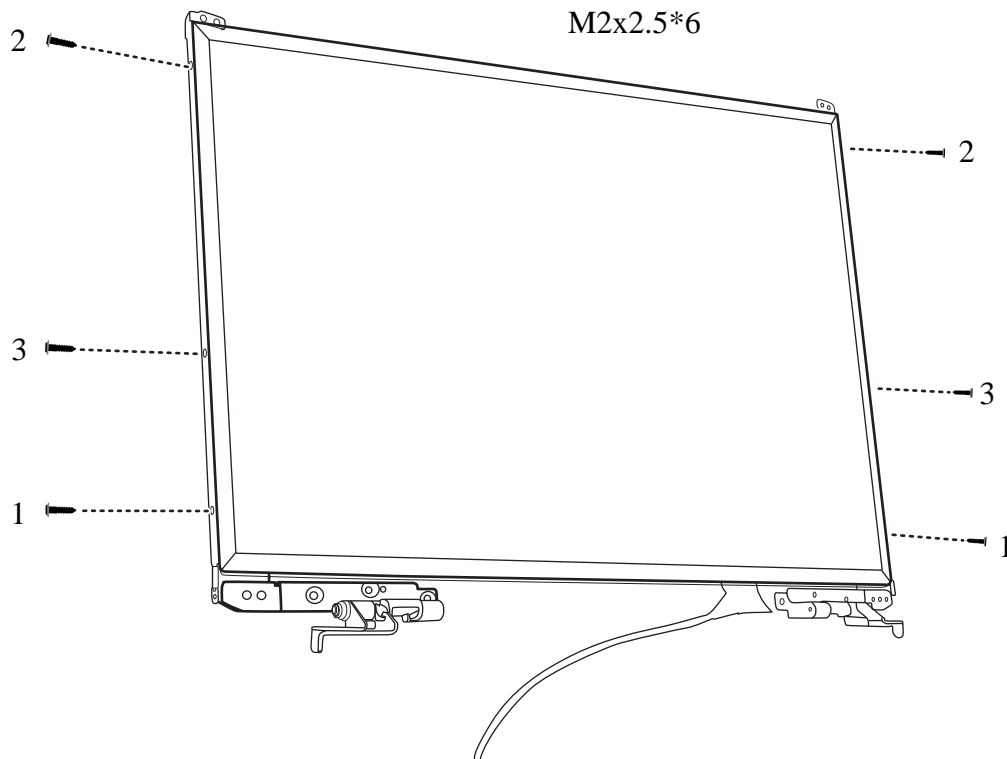

Figure 4.44 Removing the LCD Hinge Assembly

4. Turn the LCD module over and place it face down on a protective surface, such as a foam pad.

Fehler! Verwenden Sie die Registerkarte 'Start', um 標題 2 dem Text zuzuweisen, der hier angezeigt werden soll. Fehler! Verwenden Sie die Registerkarte 'Start', um 標題 2 dem Text zuzuweisen, der hier angezeigt werden soll.

4 Replacement Procedures

5. Remove the tape and LVDS cable connector. Then detach the LVDS cable.

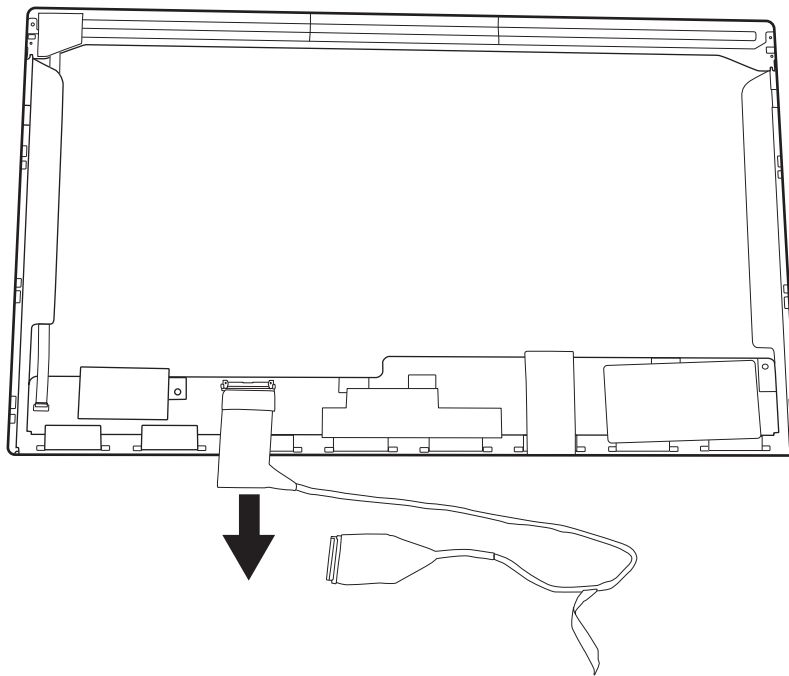

Figure 4.45 Removing the LVDS cable

NOTE:

Integrated Circuits (ICs) are fragile. Use extreme care not to apply pressure to the ICs along the edges of the LCD module.

Dispose of used LCD panels (fluorescent (FL) tubes) as required by local ordinances or regulations.

The LVDS cable must be carefully peeled away before disconnecting it from the LCD panel.

4 Replacement Procedures Fehler! Verwenden Sie die Registerkarte 'Start', um 標題 2 dem Text zuzuweisen, der hier angezeigt werden soll. Fehler! Verwenden Sie die Registerkarte 'Start', um 標題 2 dem Text zuzuweisen, der hier angezeigt werden soll.

Installing the LCD Module

Install the inverter board according to the following procedures.

1. Turn the LCD module cover and place it face down on a protective surface such as a foam pad.
2. Connect the LVDS cable to the LCD panel connector.
3. Turn the LCD right side up.
4. Seat the LCD hinge assembly in the correct position beside the LCD panel and secure it with six M2x2.5 screws according to the sequence indicated in Figure 4.46.

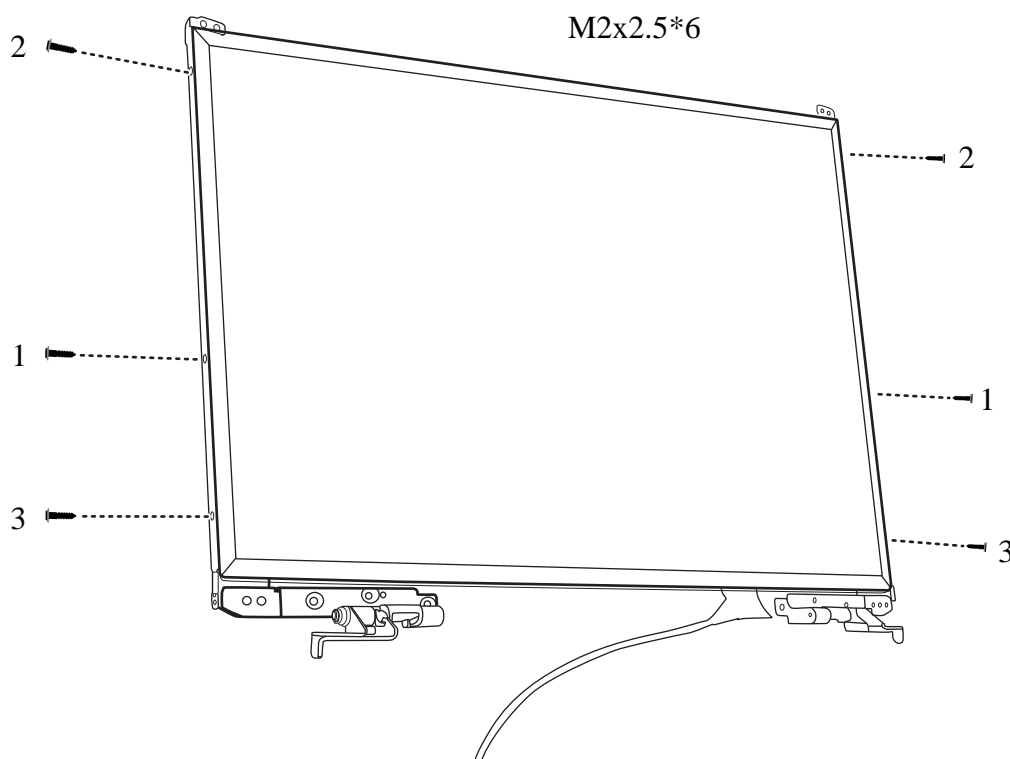

Figure 4.46 Installing the LCD Hinge Assembly

Fehler! Verwenden Sie die Registerkarte 'Start', um 標題 2 dem Text zuzuweisen, der hier angezeigt werden soll. Fehler! Verwenden Sie die Registerkarte 'Start', um 標題 2 dem Text zuzuweisen, der hier angezeigt werden soll.

4 Replacement Procedures

5. Seat the LCD module in the correct position in the LCD cover assembly and secure it to the LCD cover assembly with four M2.5x6 screws according to the sequence indicated in Figure 4.47.

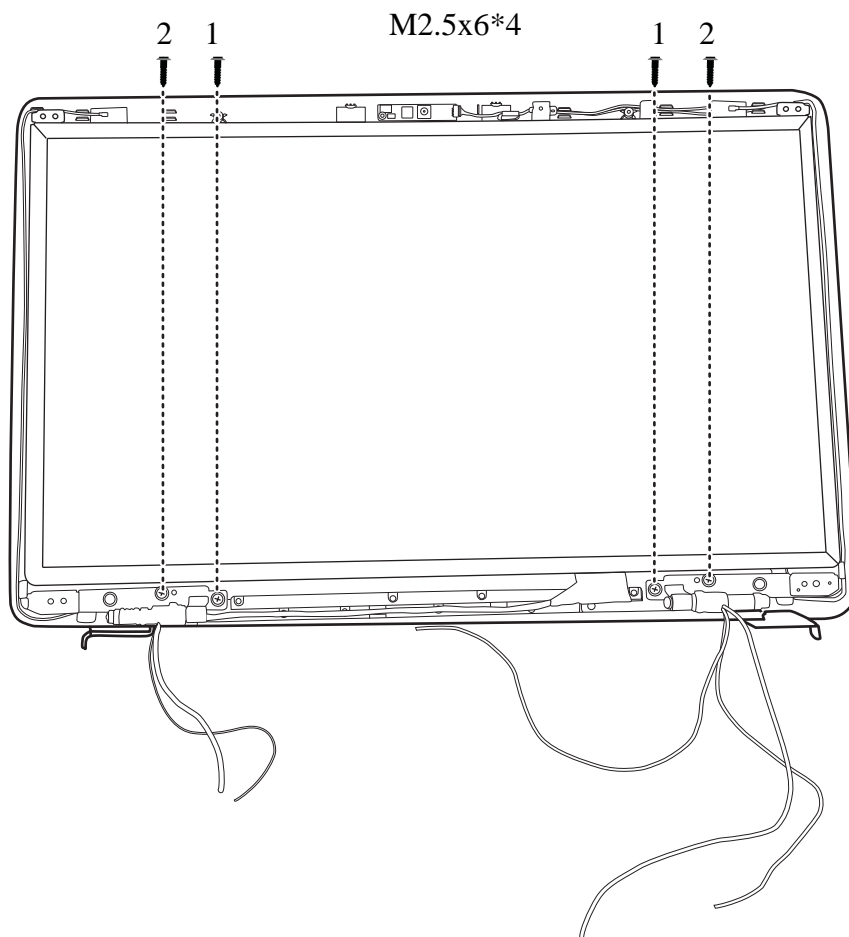

Figure 4.47 Removing the LCD Module from the LCD cover assembly

4 Replacement Procedures Fehler! Verwenden Sie die Registerkarte 'Start', um 標題 2 dem Text zuzuweisen, der hier angezeigt werden soll. Fehler! Verwenden Sie die Registerkarte 'Start', um 標題 2 dem Text zuzuweisen, der hier angezeigt werden soll.

4.23 CMOS Board and Microphone (Optional)

Removing the CMOS Board and Microphone

Remove the CMOS Board and microphone according to the following procedures and Figure 4.48.

1. Disconnect the CMOS cable from the CMOS module connector and remove the CMOS board.

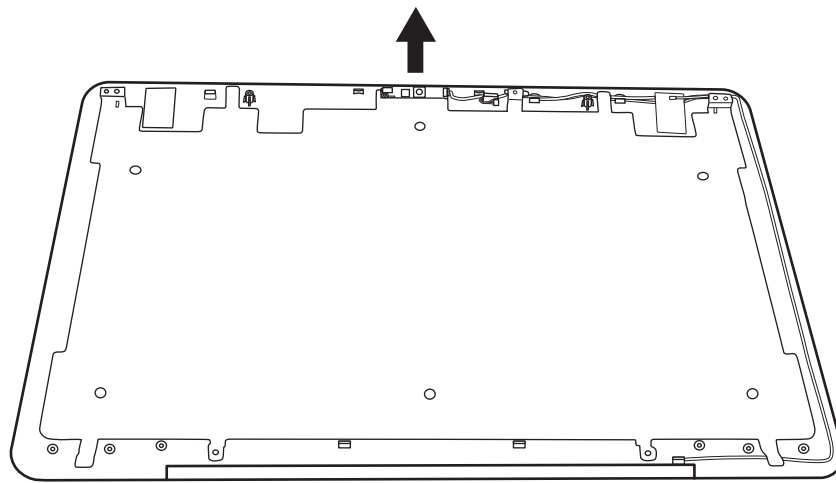

Figure 4.48 Removing the CMOS board and Microphone

2. Lift the microphone cable from the LCD cover assembly.

Installing the CMOS Board and Microphone

Install the CMOS Board and Microphone according to the following procedures.

1. Connect the CMOS module cable to CMOS module connector.
2. Seat the CMOS module and microphone in the correct position on the LCD cover assembly.

Appendix A Handling the LCD Module

Precautions for handling the LCD module

The LCD module can be easily damaged during assembly or disassembly. Observe the following precautions when handling it to prevent damaging it.

1. When installing the LCD module in the display assembly, make sure that you seat it so that it is properly aligned and maximum visibility of the display is maintained.

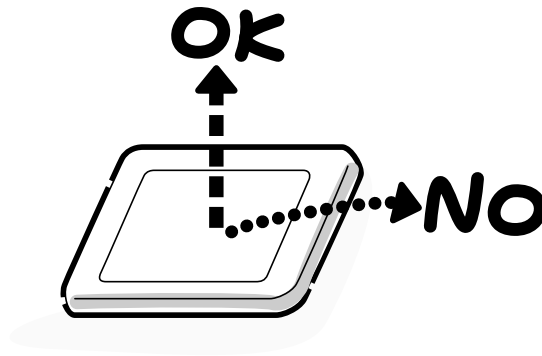

2. Be careful to align the holes at the four corners of the LCD module with the corresponding holes in the LCD cover before securing the module with screws. Do not force the module into place, because stress can affect its performance.

Note: The panel's polarized surface is easily scratched and damaged, so handle it carefully.



3. If the panel's surface gets dirty or moist, wipe it with cotton or a soft cloth. If it is still dirty, try breathing on the surface to create a light condensate and wipe it again.

If the surface is very dirty, we recommend a CRT cleaning agent. Apply the agent to a soft cloth and then wipe the panel's surface. Do not apply cleanser directly to the panel.



4. If water or other liquid is left on the panel's surface for a long period, it can change the screen's tint or stain it. Be sure to quickly wipe off any liquid.



5. Glass is used in the panel, so be careful not to drop it or let it strike a hard object, which could cause breakage or cracks.

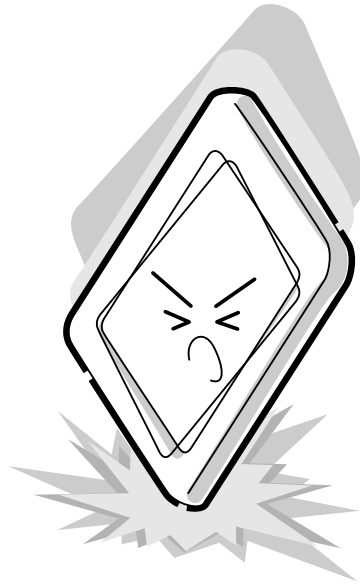

6. CMOS-LSI circuits are used in the module, so guard against damage from electrostatic discharge. Be sure to wear a wrist or ankle grounding device when handling the module.

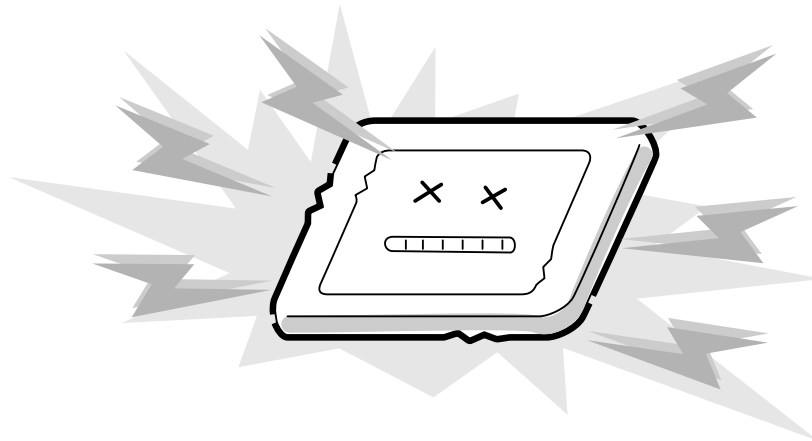

7. Do not expose the module to direct sunlight or strong ultraviolet rays for long periods.

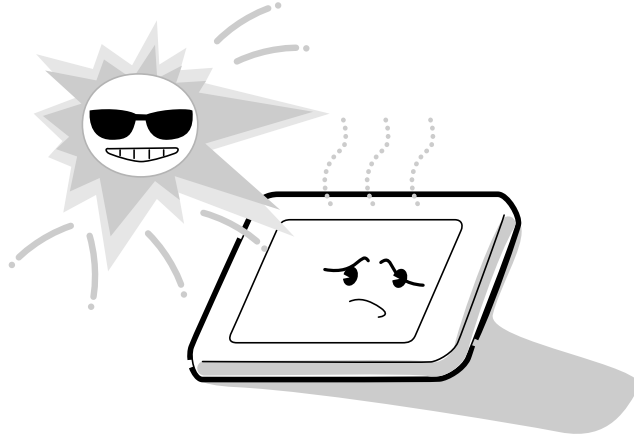

8. Do not store the module at temperatures below its specifications. Cold can cause the liquid crystals to freeze, lose their elasticity or otherwise suffer damage.

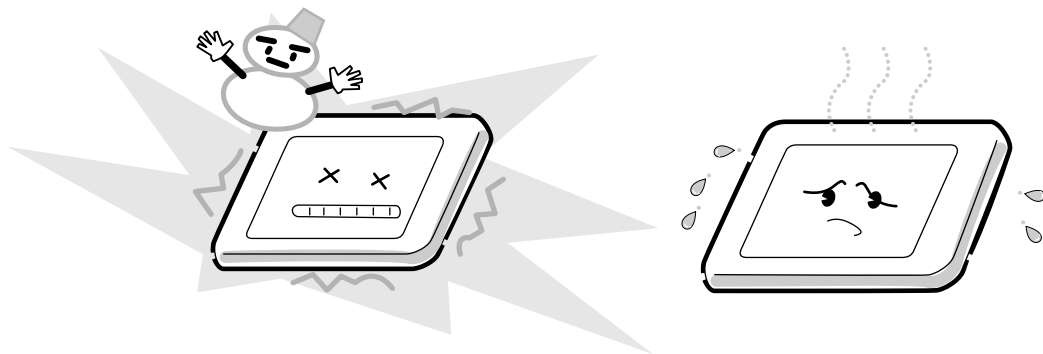

9. Do not disassemble the LCD module. Disassembly can cause malfunctions.

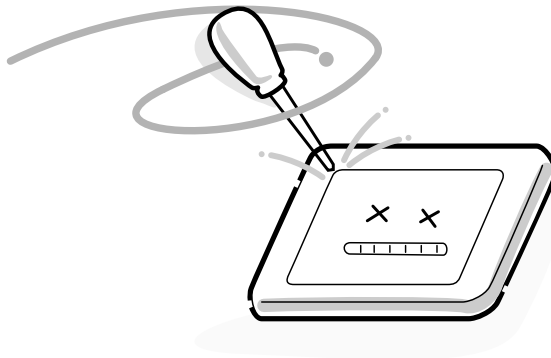

10. If you transport the module, do not use packing material that contains epoxy resin (amine) or silicon glue (alcohol or oxime). These materials can release gas that can damage the panel's polarization.

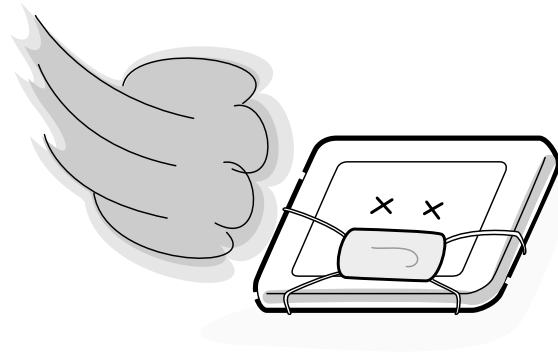

Appendix B Board Layout

B.1 System Board Top View

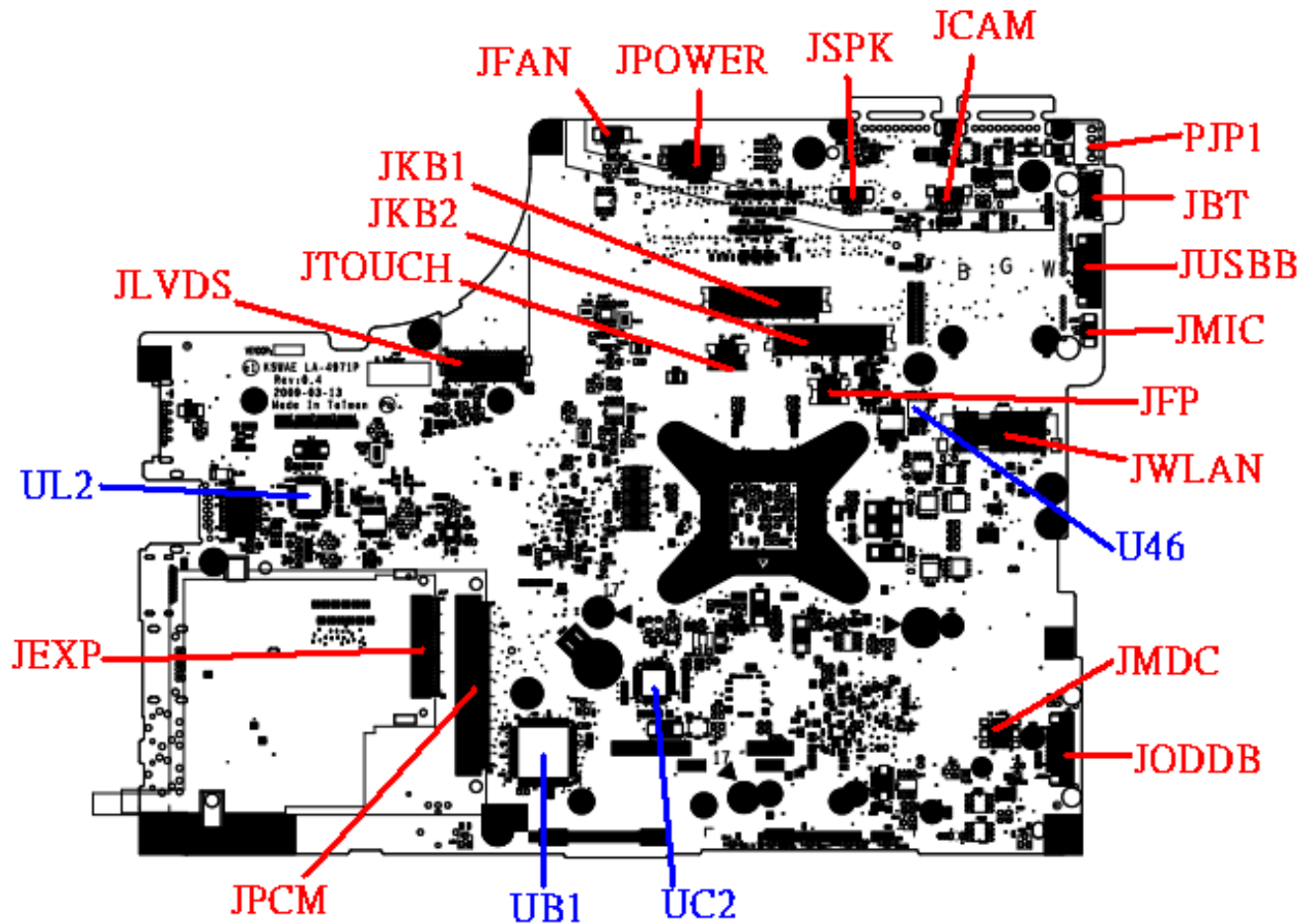

Figure B-1 System Board Layout (Top)

B.2 System Board Bottom View

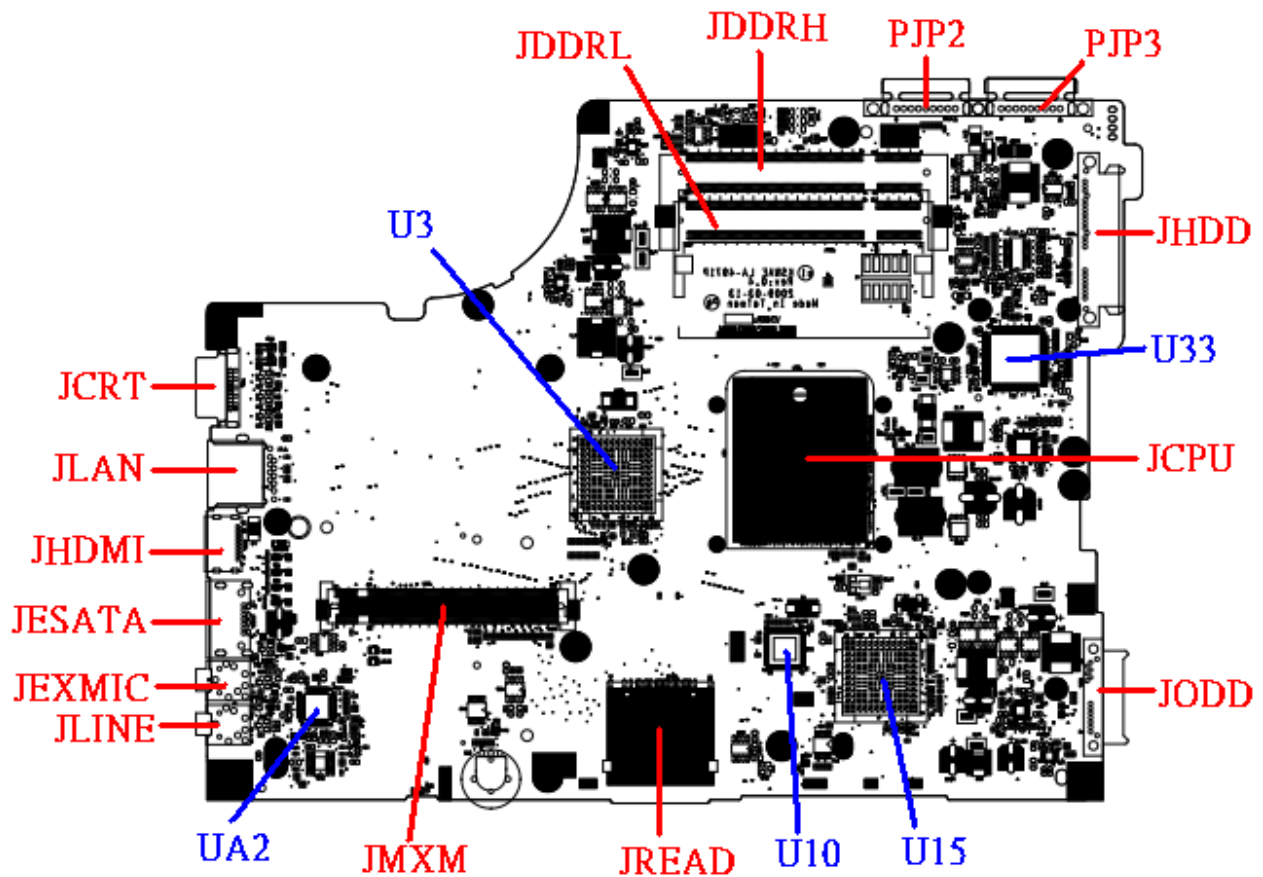

Figure B-2 System Board Layout (Bottom)

Table B-1 System Board ICs (top and bottom)

Number	Name
U3	North Bridge (PM45/ GM45 / GL40)
U10	Clock Generator (SLG8SP556VTR)
U15	South Bridge (ICH9M)
U33	EC (KB926QFD3)
U46	BIOS ROM
UA2	CODEC (ALC272-VA2-GR)
UB1	Card Bus Controller (OZ601TN-A1)
UC2	Card Reader Controller (RTS5159-VDD-GR)
UL2	LAN Conroller (RTL8103EL-GR)

Table B-2 System Board Connectors (top and bottom)

Number	Name
JCPU	CPU Socket
JFAN	Fan conn.
JDDRH, JDDRL	DDRII conn.
JCRT	CRT conn.
JMXM	VGA/B conn.
JREAD	3 in 1 Card Reader conn.
JMIC	Microphone conn.
JSPK	Speaker conn.
JEXP	Express Card conn.
JPCM	Card Bus conn.
JWLAN	WLAN conn.
JMDC	MDC conn.
JHDD	SATA HDD conn.
JODD	ODD conn.
JCAM	Camera conn.
JBT	Bluetooth conn.
JFP	Fingerprint/B conn.
JKB1	Keyboard conn.
JPOWER	Power/B conn.
JESATA	ESATA/USB Combo conn.
JLAN	LAN conn.

JLINE	Headphones conn.
JEXMIC	External MIC conn.
JHDMI	HDMI conn.
JLVDS	LVDS conn.
JUSBB	USB/B conn.
PJP1	AC Adaptor conn.
PJP2	Battery conn.

Appendix C Pin Assignments

System Board

C.1 JFAN

Table C-1 FAN I/F pin assignments (3-pin)

Pin No.	Signal name	I/O	Pin No.	Signal Name	I/O
1	+FAN1	-	2	FAN_SPEED1	O
3	GND	-			

C.2 JLVDS

Table C-2 LVDS I/F pin assignments (40-pin)

Pin No.	Signal name	I/O	Pin No.	Signal Name	I/O
1	GND	-	2	+5V_LVDS_CAM	-
3	LCD_TXCLK+	O	4	USB20_P9_R_CAM	O
5	LCD_TXCLK-	O	6	USB20_N9_R_CAM	O
7	GND	-	8	GND	-
9	DAC_BRIG	O	10	INT_MIC_R	O
11	INVT_PWM	O	12	LCD_TXOUT0+	O
13	GND	-	14	LCD_TXOUT0-	O
15	LCD_TZCLK+	O	16	LCD_TXOUT1+	O
17	LCD_TZCLK-	O	18	LCD_TXOUT1-	O
19	GND	-	20	LCD_TXOUT2+	O
21	LCD_EDID_CLK	O	22	LCD_TXOUT2-	O
23	LCD_EDID_DATA	O	24	GND	-
25	+LCDVDD_R	-	26	LCD_TZOUT0+	O
27	+LCDVDD_R	-	28	LCD_TZOUT0-	O
29	+3VS	-	30	LCD_TZOUT1+	O
31	NC	-	32	LCD_TZOUT1-	O
33	+LCD_INV	-	34	LCD_TZOUT2+	O
35	+LCD_INV	-	36	LCD_TZOUT2-	O
37	+LCD_INV	-	38	GND	-
39	+LCD_INV	-	40	BKOFF#	O

C.3 JCRT

Table C-3 CRT pin assignments (15-pin)

Pin No.	Signal name	I/O	Pin No.	Signal Name	I/O
1	RED_L	O	2	GREEN_L	O
3	BLUE_L	O	4	GND	-
5	GND	-	6	GND	-
7	GND	-	8	GND	-
9	+CRT_VCC	O	10	GND	-
11	NC	-	12	D_DDCCDATA	O
13	HSYNC	O	14	VSYNC	O
15	D_DDCCCLK	O			

C.4 JHDMI

Table C-4 HDMI I/F pin assignments (19-pin)

Pin No.	Signal name	I/O	Pin No.	Signal Name	I/O
1	HDMI_R_D2+	O	2	GND	-
3	HDMI_R_D2-	O	4	HDMI_R_D1+	O
5	GND	-	6	HDMI_R_D1-	O
7	HDMI_R_D0+	O	8	GND	-
9	HDMI_R_D0-	O	10	HDMI_R_CK+	O
11	GND	-	12	HDMI_R_CK-	O
13	HDMI_CEC	I/O	14	GND	-
15	HDMI_SCLK	I	16	HDMI_SDATA	I
17	GND		18	+HDMI_5V_OUT	-
19	HDMI_HPD	I			

C.5 JFP

Table C-5 Finger Printer Connector pin assignments (4-pin)

Pin No.	Signal name	I/O	Pin No.	Signal Name	I/O
1	+3VS_FP	-	2	USB20_N7	I/O
3	USB20_P7	I/O	4	GND	-

C.6 JHDD

Table C-6 HDD I/F pin assignments (22-pin)

Pin No.	Signal name	I/O	Pin No.	Signal Name	I/O
1	GND	-	2	SATA_TXP1	O
3	SATA_TXN1	O	4	GND	-
5	SATA_IRX_DT X_N1	O	6	SATA_IRX_DT X_P1	O
7	GND	-	8	+3VS	-
9	+3VS	-	10	+3VS	-
11	GND	-	12	GND	-
13	GND	-	14	+5VS	-
15	+5VS	-	16	+5VS	-
17	GND	-	18	NC	-
19	GND	-	20	NC	-
21	NC	-	22	NC	-

C.7 JODD

Table C-7 SATA ODD I/F pin assignments (14-pin)

Pin No.	Signal name	I/O	Pin No.	Signal Name	I/O
1	GND	-	2	SATA_STX_D RX_P3_16	O
3	SATA_STX_D RX_N3_16	O	4	GND	-
5	SATA_RXN3_ C_16	O	6	SATA_RXP3_ C_16	O
7	GND	-	8	NC	-
9	+5VS	-	10	+5VS	-
11	NC	-	12	GND	-
13	GND	-	14	GND	-

C.8 JESATA

Table C-8 eSATA/USB I/F pin assignments (11-pin)

Pin No.	Signal name	I/O	Pin No.	Signal Name	I/O
1	+USB_VCCB		2	USB20_N2_R_S	
3	USB20_P2_R_S		4	GND	
5	GND		6	SATA_TXP2	
7	SATA_TXN2		8	GND	
9	SATA_RXN2		10	SATA_RXP2	
11	GND				

C.9 JBT

Table C-9 Bluetooth Connector pin assignments (10-pin)

Pin No.	Signal name		Pin No.	Signal Name	I/O
1	GND		2	+3VS	
3	+BT_VCC		4	NC	
5	BT_RESET#		6	BT_DET#	
7	NC		8	USB20_N6	
9	USB20_P6		10	GND	

C.10 JCAM

Table C-10 Internal Camera Connector pin assignments (5-pin)

Pin No.	Signal name	I/O	Pin No.	Signal Name	I/O
1	+CAM_VDD	-	2	USB20_N9_R	I/O
3	USB20_P9_R	I/O	4	GND	-
5	GND	-			

C.11 JWLAN

Table C-11 WLAN Connector pin assignments (52-pin)

Pin No.	Signal name	I/O	Pin No.	Signal Name	I/O
A1	NC		A2	+3VS	
A3	NC		A4	GND	
A5	NC		A6	+1.5VS	
A7	CLKREQ_MCARD 2#		A8	NC	
A9	GND		A10	NC	
A11	CLK_PCIE_MCAR D2#		A12	NC	
A13	CLK_PCIE_MCAR D2		A14	NC	
A15	GND		A16	NC	
A17	NC		A18	GND	
A19	NC		A20	WL_OFF#	
A21	GND		A22	PLT_RST#	
A23	PCIE_PTX_C_IRX _N2		A24	+3VS	
A25	PCIE_PTX_C_IRX _P2		A26	GND	
A27	GND		A28	+1.5VS	
A29	GND		A30	SMB_CK_CLK1	
A31	PCIE_ITX_C_PRX _N2		A32	SMB_CK_DAT1	
A33	PCIE_ITX_C_PRX _P2		A34	GND	
A35	GND		A36	USB20_N8	
A37	GND		A38	USB20_P8	
A39	+3VS		A40	GND	
A41	+3VS		A42	NC	
A43	GND		A44	NC	
A45	NC		A46	NC	
A47	NC		A48	+1.5VS	
A49	E51_TXD_R		A50	GND	
A51	E51_RXD_R		A52	+3VS	

C.12 JEXP

Table C-12 New Card Connector pin assignments (26-pin)

Pin No.	Signal name	I/O	Pin No.	Signal Name	I/O
1	GND		2	USB20_N5	
3	USB20_P5		4	CP_USB#	
5	NC		6	NC	
7	SMB_CK_CLK0		8	SMB_CK_DAT0	
9	+1.5VS_CARD		10	+1.5VS_CARD	
11	EC_SWI_R#		12	+3VALW_CARD	
13	PERST#		14	+3VS_CARD	
15	+3VS_CARD		16	CLKREQ#	
17	EXP_CPPE#		18	CLK_PCIE_NCAR D#	
19	CLK_PCIE_NCAR D		20	GND	
21	PCIE_PTX_C_IRX _N0		22	PCIE_PTX_C_IRX _P0	
23	GND		24	PCIE_ITX_C_PRX _N0	
25	PCIE_ITX_C_PRX _P0		26	GND	

C.13 JLAN

Table C-13 LAN Connector pin assignments (14-pin)

Pin No.	Signal name	I/O	Pin No.	Signal Name	I/O
1	RJ45_MIDI0+	I/O	2	RJ45_MIDI0-	I/O
3	RJ45_MIDI1+	I/O	4	NC	
5	NC		6	RJ45_MIDI1-	I/O
7	NC		8	NC	
9	+3V_LAN		10	LAN_SK_LAN_LI NK#	
11	+3V_LAN		12	LAN_ACTIVITY#	
13	LANGND		14	LANGND	

C.14 JUSBB

Table C-14 USB/B Connector pin assignments (12-pin)

Pin No.	Signal name	I/O	Pin No.	Signal Name	I/O
1	+USB_VCCA		2	+USB_VCCA	
3	+USB_VCCA		4	+USB_VCCA	
5	NC		6	GND	
7	USB20_N0_R		8	USB20_P0_R	
9	GND		10	USB20_N1_R	
11	USB20_P1_R		12	GND	

C.15 JDDR1, JPDDRH

Table C-15 SODIMM I/F pin assignments (200-PIN) (1/4)

Pin No.	Signal name	I/O	Pin No.	Signal Name	I/O
1	VREF	O	2	VSS	O
3	VSS	O	4	DQ4	I/O
5	DQ0	I/O	6	DQ5	I/O
7	DQ1	I/O	8	VSS	O
9	VSS	O	10	DM0	I/O
11	DQS0#	I/O	12	VSS	O
13	DQS0	I/O	14	DQ6	I/O
15	VSS	O	16	DQ7	I/O
17	DQ2	I/O	18	VSS	O
19	DQ3	I/O	20	DQ12	I/O
21	VSS	O	22	DQ13	I/O
23	DQ8	I/O	24	VSS	I/O
25	DQ9	I/O	26	DM1	O
27	VSS	O	28	VSS	O
29	DQS1#	I/O	30	CK0	I/O
31	DQS1	I/O	32	CK0#	I/O

Table C-15 SODIMM I/F pin assignments (200-PIN) (2/4)

Pin No.	Signal name	I/O	Pin No.	Signal Name	I/O
33	VSS	O	34	VSS	O
35	DQ10	I/O	36	DQ14	I/O
37	DQ11	I/O	38	DQ15	I/O
39	VSS	O	40	VSS	O
41	VSS	O	42	VSS	O
43	DQ16	I/O	44	DQ20	I/O
45	DQ17	I/O	46	DQ21	I/O
47	VSS	O	48	VSS	O
49	DQS2#	I/O	50v	NC	-
51	DQS2	I/O	52	DM2	I/O
53	VSS	O	54	VSS	O
55	DQ18	I/O	56	DQ22	I/O
57	DQ19	I/O	58	DQ23	I/O
59	VSS	O	60	VSS	O
61	DQ24	I/O	62	DQ28	I/O
63	DQ25	I/O	64	DQ29	I/O
65	VSS	O	66	VSS	O
67	DM3	I/O	68	DQS3#	I/O
69	NC	-	70	DQS3	I/O
71	VSS	O	72	VSS	O
73	DQ26	I/O	74	DQ30	I/O
75	DQ27	I/O	76	DQ31	I/O
77	VSS	O	78	VSS	O
79	CKE0	I/O	80	NC/CKE1	I/O
81	VDD	O	82	VDD	O
83	NC	-	84	NC/A15	-
85	BA2	I/O	86	NC/A14	-
87	VDD	O	88	VDD	O
89	A12	I/O	90	A11	I/O
91	A9	I/O	92	A7	I/O
93	A8	I/O	94	A6	I/O
95	VDD	O	96	VDD	O

Table C-15 SODIMM I/F pin assignments (200-PIN) (3/4)

Pin No.	Signal name	I/O	Pin No.	Signal Name	I/O
97	A5	I/O	98	A4	I/O
99	A3	I/O	100	A2	I/O
101	A1	I/O	102	A0	I/O
103	VDD	O	104	VDD	O
105	A10/AP	I/O	106	BA1	I/O
107	BAD	I/O	108	RAS#	I/O
109	WE#	I/O	110	S0#	I/O
111	VDD	O	112	VDD	O
113	CAS#	I/O	114	ODT0	I/O
115	NC/S1#	I/O	116	NC/A13	I/O
117	VDD	O	118	VDD	O
119	NC/ODT1	I/O	120	NC	-
121	VSS	O	122	VSS	O
123	DQ32	I/O	124	DQ36	I/O
125	DQ33	I/O	126	DQ37	I/O
127	VSS	O	128	VSS	O
129	DQS4#	I/O	130	DM4	I/O
131	DQS4	I/O	132	VSS	O
133	VSS	O	134	DQ38	I/O
135	DQ34	I/O	136	DQ39	I/O
137	DQ35	I/O	138	VSS	O
139	VSS	O	140	DQ44	I/O
141	DQ40	I/O	142	DQ45	I/O
143	DQ41	I/O	144	VSS	O
145	VSS	O	146	DQS5#	I/O
147	DM5	I/O	148	DQS5	I/O
149	VSS	O	150	VSS	O
151	DQ42	I/O	152	DQ46	I/O
153	DQ43	I/O	154	DQ47	I/O
155	VSS	O	156	VSS	O
157	DQ48	I/O	158	DQ52	I/O

159	DQ49	I/O	160	DQ53	I/O
-----	------	-----	-----	------	-----

Table C-15 SODIMM I/F pin assignments (200-PIN) (4/4)

Pin No.	Signal name	I/O	Pin No.	Signal Name	I/O
161	VSS	O	162	VSS	O
163	DQ18	I/O	164	DQ22	I/O
165	DQ19	I/O	166	DQ23	I/O
167	VSS	O	168	VSS	O
169	DQ24	I/O	170	DQ28	I/O
171	DQ25	I/O	172	DQ29	I/O
173	VSS	O	174	VSS	O
175	DM3	I/O	176	DQS3#	I/O
177	NC	-	178	DQS3	I/O
179	VSS	O	180	VSS	O
181	DQ26	I/O	182	DQ30	I/O
183	DQ27	I/O	184	DQ31	I/O
185	VSS	O	186	VSS	O
187	CKE0	I/O	188	NC/CKE1	I/O
189	VDD	O	190	VDD	O
191	NC	-	192	NC/A15	-
193	BA2	I/O	194	NC/A14	-
195	VDD	O	196	VDD	O
197	A12	I/O	198	A11	I/O
199	A9	I/O	200	A7	I/O

C.16 JLINE

Table C-16 HEADPHONE Connector pin assignments (6-pin)

Pin No.	Signal name	I/O	Pin No.	Signal Name	I/O
1	GNDA		2	HP_L_L	
3	HP_R_L		4	NBA_PLUG	
5	GNDA		6	NC	

C.17 JMIC

Table C-17 Internal Microphone Connector pin assignments (2-pin)

Pin No.	Signal name	I/O	Pin No.	Signal Name	I/O
1	INT_MIC		2	GNDA	

C.18 JKB1

Table C-18 Keyboard Connector pin assignments (34-pin)

Pin No.	Signal name	I/O	Pin No.	Signal Name	I/O
1	NUM_LED#		2	NC	
3	CAPS_LED#		4	+3VS	
5	KSI1		6	KSI6	
7	KSI5		8	KSI0	
9	KSI4		10	KSI3	
11	KSI2		12	KSI7	
13	KSO15		14	KSO12	
15	KSO11		16	KSO10	
17	KSO9		18	KSO8	
19	KSO13		20	KSO7	
21	KSO6		22	KSO14	
23	KSO5		24	KSO3	
25	KSO4		26	KSO0	
27	KSO1		28	KSO2	
29	NC		30	NC	
31	KSO17		32	NC	
33	KSO16		34	+3VS	

C.19 JREAD

Table C-19 CARD READER connector pin assignments (21-pin)

Pin No.	Signal name	I/O	Pin No.	Signal Name	I/O
1	SDWP#		2	SD_DATA1	
3	SD_MS_DATA0		4	GND	
5	GND		6	MSBS	
7	SDCLK		8	MS_DATA1	
9	SD_MS_DATA0		10	+VCC_3IN1	
11	MS_DATA2_SD_D ATA7		12	GND	
13	MSCD#		14	MS_DATA3_SD_D ATA6	
15	SDCMD		16	MSCLK	
17	+VCC_3IN1		18	SD_DATA3	
19	GND		20	SD_DATA2	
21	SDCD#				

C.20 JMXM

Table C-20 VGA/B Connector pin assignments (200-PIN) (1/4)

Pin No.	Signal name	I/O	Pin No.	Signal Name	I/O
1	+MXM_B+		2	+1.8VS	
3	+MXM_B+		4	+1.8VS	
5	+MXM_B+		6	+1.8VS	
7	+MXM_B+		8	+1.8VS	
9	+MXM_B+		10	+1.8VS	
11	+MXM_B+		12	+1.8VS	
13	+MXM_B+		14	+1.8VS	
15	+MXM_B+		16	SUSP#	
17	GND		18	+5VALW	
19	GND		20	GND	
21	GND		22	GND	
23	GND		24	GND	
25	PCIE_GTX_C_MRX_N15		26	GND	
27	PCIE_GTX_C_MRX_P15		28	PCIE_MTX_C_GRX_N15	

29	GND		30	PCIE_MTX_C_GRX_P15	
31	PCIE_GTX_C_MRX_N14		32	GND	
33	PCIE_GTX_C_MRX_P14		34	PCIE_MTX_C_GRX_N14	
35	GND		36	PCIE_MTX_C_GRX_P14	
37	PCIE_GTX_C_MRX_N13		38	GND	
39	PCIE_GTX_C_MRX_P13		40	PCIE_MTX_C_GRX_N13	
41	GND		42	PCIE_MTX_C_GRX_P13	
43	PCIE_GTX_C_MRX_N12		44	GND	
45	PCIE_GTX_C_MRX_P12		46	PCIE_MTX_C_GRX_N12	
47	GND		48	PCIE_MTX_C_GRX_P12	
49	PCIE_GTX_C_MRX_N11		50	GND	
51	PCIE_GTX_C_MRX_P11		52	PCIE_MTX_C_GRX_N11	
53	GND		54	PCIE_MTX_C_GRX_P11	
55	PCIE_GTX_C_MRX_N10		56	GND	
57	PCIE_GTX_C_MRX_P10		58	PCIE_MTX_C_GRX_N10	
59	GND		60	PCIE_MTX_C_GRX_P10	
61	PCIE_GTX_C_MRX_N9		62	GND	
63	PCIE_GTX_C_MRX_P9		64	PCIE_MTX_C_GRX_N9	

Table C-20 VGA/B Connector pin assignments (200-PIN) (2/4)

Pin No.	Signal name	I/O	Pin No.	Signal Name	I/O
65	GND		66	PCIE_MTX_C_GRX_P9	
67	PCIE_GTX_C_MRX_N8		68	GND	
69	PCIE_GTX_C_MRX_P8		70	PCIE_MTX_C_GRX_N8	
71	GND		72	PCIE_MTX_C_GRX_P8	
73	PCIE_GTX_C_MRX_N7		74	GND	
75	PCIE_GTX_C_MRX_P7		76	PCIE_MTX_C_GRX_N7	
77	GND		78	PCIE_MTX_C_GRX_P7	
79	PCIE_GTX_C_MRX_N6		80	GND	
81	PCIE_GTX_C_MRX_P6		82	PCIE_MTX_C_GRX_N6	
83	GND		84	PCIE_MTX_C_GRX_P6	
85	PCIE_GTX_C_MRX_N5		86	GND	
87	PCIE_GTX_C_MRX_P5		88	PCIE_MTX_C_GRX_N5	
89	GND		90	PCIE_MTX_C_GRX_P5	
91	PCIE_GTX_C_MRX_N4		92	GND	

93	PCIE_GTX_C_MRX_P4	94	PCIE_MTX_C_GRX_N4
95	GND	96	PCIE_MTX_C_GRX_P4
97	PCIE_GTX_C_MRX_N3	98	GND
99	PCIE_GTX_C_MRX_P3	100	PCIE_MTX_C_GRX_N3
101	GND	102	PCIE_MTX_C_GRX_P3
103	PCIE_GTX_C_MRX_N2	104	GND
105	PCIE_GTX_C_MRX_P2	106	PCIE_MTX_C_GRX_N2
107	GND	108	PCIE_MTX_C_GRX_P2
109	PCIE_GTX_C_MRX_N1	110	GND
111	PCIE_GTX_C_MRX_P1	112	PCIE_MTX_C_GRX_N1

Table C-20 VGA/B Connector pin assignments (200-PIN) (3/4)

Pin No.	Signal name	I/O	Pin No.	Signal Name	I/O
113	GND		114	PCIE_MTX_C_GRX_P1	
115	PCIE_GTX_C_MRX_N0		116	GND	
117	PCIE_GTX_C_MRX_P0		118	PCIE_MTX_C_GRX_N0	
119	GND		120	PCIE_MTX_C_GRX_P0	
121	CLK_PCIE_VGA#		122	NC	
123	CLK_PCIE_VGA		124	NC	
125	NC		126	GND	
127	PLT_RST#		128	NC	
129	NC		130	GND	
131	NC		132	NC	
133	EC_SMB_DA2		134	NC	
135	EC_SMB_CK2		136	VGA_CRT_R	
137	NC		138	GND	
139	VGA_CRT_HSYNC		140	VGA_CRT_G	
141	VGA_CRT_VSYNC		142	GND	
143	VGA_CRT_CLK		144	VGA_CRT_B	
145	VGA_CRT_DATA		146	GND	
147	NC		148	LCD_TZCLK-	
149	NC		150	LCD_TZCLK+	
151	GND		152	GND	
153	NC		154	NC	
155	NC		156	NC	
157	NC		158	NC	

Table C-20 VGA/B Connector pin assignments (200-PIN) (4/4)

Pin No.	Signal name	I/O	Pin No.	Signal Name	I/O
159	NC		160	LCD_TZOUT2-	
161	NC		162	LCD_TZOUT2+	
163	GND		164	GND	
165	NC		166	LCD_TZOUT1-	
167	NC		168	LCD_TZOUT1+	
169	GND		170	GND	
171	NC		172	LCD_TZOUT0-	
173	NC		174	LCD_TZOUT0+	
175	GND		176	GND	
177	NC		178	LCD_TXCLK-	
179	NC		180	LCD_TXCLK+	
181	NC		182	GND	
183	NC		184	NC	
185	NC		186	NC	
187	GND		188	GND	
189	NC		190	LCD_TXOUT2-	
191	NC		192	LCD_TXOUT2+	
193	GND		194	GND	
195	NC		196	LCD_TXOUT1-	
197	NC		198	LCD_TXOUT1+	
199	GND		200	GND	
201	NC		202	LCD_TXOUT0-	
203	NC		204	LCD_TXOUT0+	
205	HPD		206	GND	
207	VGA_HDMI_CLK-		208	LCD_EDID_DATA	
209	VGA_HDMI_CLK+		210	LCD_EDID_CLK	
211	GND		212	VGA_ENVDD	
213	VGA_HDMI_TXD2-		214	NC	
215	VGA_HDMI_TXD2+		216	VGA_ENBKL	
217	GND		218	HDMIDAT_VGA	
219	VGA_HDMI_TXD1-		220	HDMICLK_VGA	
221	VGA_HDMI_TXD1+		222	NC	
223	GND		224	GND	
225	VGA_HDMI_TXD0-		226	+3VS	

227	VGA_HDMI_TXD0+		228	+3VS	
229	GND		230	+3VS	

C.21 JEXMIC

Table C-21 EXMIC connector pin assignments (6-pin)

Pin No.	Signal name	I/O	Pin No.	Signal Name	I/O
1	GND A		2	MIC1_L_L	
3	MIC1_L_R		4	MIC_SENSE	
5	GND A		6	NC	

C.22 JSPK

Table C-22 SPK connector pin assignments (4-pin)

Pin No.	Signal name	I/O	Pin No.	Signal Name	I/O
1	SPK_L1		2	SPK_L2	
3	SPK_R1		4	SPK_R2	

C.23 JPOWER

Table C-23 Power/B connector pin assignments (10-pin)

Pin No.	Signal name	I/O	Pin No.	Signal Name	I/O
1	ON/OFFBTN#		2	KSO0	
3	KSI1		4	KSI3	
5	KSI5		6	KSI2	
7	NC		8	NC	
9	NC		10	GND	

C.24 JMDC

Table C-24 MDC connector pin assignments (12-pin)

Pin No.	Signal name	I/O	Pin No.	Signal Name	I/O
1	GND		2	+3VALW	
3	HDA_SDOOUT_MDC		4	NC	
5	GND		6	+3VALW	
7	HDA_SYNC_MDC		8	GND	
9	HDA_SDIN1_MDC		10	GND	
11	HDA_RST#_MDC		12	HDA_BITCLK_MDC	

C.25 JPCM

Table C-25 Card Bus connector pin assignments (68-pin)

Pin No.	Signal name	I/O	Pin No.	Signal Name	I/O
1	GND		2	S1_D3	
3	S1_D4		4	S1_D5	
5	S1_D6		6	S1_D7	
7	S1_CE1#		8	S1_A10	
9	S1_OE#		10	S1_A11	
11	S1_A9		12	S1_A8	
13	S1_A13		14	S1_A14	
15	S1_WE#		16	S1_RDY#	
17	+S1_VCC		18	+S1_VCC	
19	S1_A16_R		20	S1_A15	
21	S1_A12		22	S1_A7	
23	S1_A6		24	S1_A5	
25	S1_A4		26	S1_A3	
27	S1_A2		28	S1_A1	
29	S1_A0		30	S1_D0	
31	S1_D1		32	S1_D2	
33	S1_WP		34	GND	
35	GND		36	S1_CD1#	
37	S1_D11		38	S1_D12	
39	S1_D13		40	S1_D14	

41	S1_D15	42	S1_CE2#
43	S1_VS1	44	S1_IORD#
45	S1_IOWR#	46	S1_A17
47	S1_A18	48	S1_A19
49	S1_A20	50	S1_A21
51	+S1_VCC	52	+S1_VCC
53	S1_A22	54	S1_A23
55	S1_A24	56	S1_A25
57	S1_VS2	58	S1_RST
59	S1_WAIT#	60	S1_INPACK#
61	S1_REG#	62	S1_BVD2
63	S1_BVD1	64	S1_D8
65	S1_D9	66	S1_D10
67	S1_CD2#	68	GND

Appendix D Keyboard Scan/Character Codes

Table D-1 Scan codes (set 1 and set 2) (1/4)

Cap No.	Keytop	Code set 1		Code set 2		Note	
		Make	Break	Make	Break		
01	' ~	29	A9	0E	F0	0E	
02	1 !	02	82	16	F0	16	
03	2 @	03	83	1E	F0	1E	
04	3 #	04	84	26	F0	26	
05	4 \$	05	85	25	F0	25	
06	5 %	06	86	2E	F0	2E	
07	6 ^	07	87	36	F0	36	
08	7 &	08	88	3D	F0	3D	*2
09	8 *	09	89	3E	F0	3E	*2
10	9 (0A	8A	46	F0	46	*2
11	0)	0B	8B	45	F0	45	
12	- _	0C	8C	4E	F0	4E	
13	= +	0D	8D	55	F0	55	
15	BkSp	0E	8E	66	F0	66	
16	Tab	0F	8F	0D	F0	0D	
17	Q	10	90	15	F0	15	
18	W	11	91	1D	F0	1D	
19	E	12	92	24	F0	24	
20	R	13	93	2D	F0	2D	
21	T	14	94	2C	F0	2C	
22	Y	15	95	35	F0	35	
23	U	16	96	3C	F0	3C	*2
24	I	17	97	43	F0	43	*2
25	O	18	98	44	F0	44	*2
26	P	19	99	4D	F0	4D	*2
27	[{	1A	9A	54	F0	54	
28] }	1B	9B	5B	F0	5B	

Table D-1 Scan codes (set 1 and set 2) (2/4)

Cap No.	Keypop	Code set 1		Code set 2			Note
		Make	Break	Make	Break		
29	\	2B	AB	5D	F0	5D	*5
30	Caps Lock	3A	BA	58	F0	58	
31	A	1E	9E	1C	F0	1C	
32	S	1F	9F	1B	F0	1B	
33	D	20	A0	23	F0	23	
34	F	21	A1	2B	F0	2B	
35	G	22	A2	34	F0	34	
36	H	23	A3	33	F0	33	
37	J	24	A4	3B	F0	3B	*2
38	K	25	A5	42	F0	42	*2
39	L	26	A6	4B	F0	4B	*2
40	; :	27	A7	4C	F0	4C	*2
41	' "	28	A8	52	F0	52	
43	Enter	1C	9C	5A	F0	5A	*3
44	Shift (L)	2A	AA	12	F0	12	
45	No.102 key	56	D6	61	F0	61	
46	Z	2C	AC	1A	F0	1A	
47	X	2D	AD	22	F0	22	
48	C	2E	AE	21	F0	21	
49	V	2F	AF	2A	F0	2A	
50	B	30	B0	32	F0	32	
51	N	31	B1	31	F0	31	
52	M	32	B2	3A	F0	3A	*2
53	, <	33	B3	41	F0	41	*2
54	. >	34	B4	49	F0	49	*2
55	/ ?	35	B5	4A	F0	4A	*2
57	Shift (R)	36	B6	59	F0	59	

Table D-1 Scan codes (set 1 and set 2) (3/4)

Cap No.	Keytop	Code set 1		Code set 2			Note
		Make	Break	Make	Break		
58	Ctrl(L)	1D	9D	14	F0	14	*3
60	Alt (L)	38	B8	11	F0	11	*3
61	Space	39	B9	29	F0	29	
62	ALT (R)	E0 38	E0 B8	E0 11	E0 F0	11	
64	Ctrl(R)	E0 1D	E0 9D	E0 14	E0 F0	14	
75	Ins	E0 52	E0 D2	E0 70	E0 F0	70	*1
76	Del	E0 53	E0 D3	E0 71	E0 F0	71	*1
79	←	E0 4B	E0 CB	E0 6B	E0 F0	6B	*1
80	Home	E0 47	E0 C7	E0 6C	E0 F0	6C	*1
81	End	E0 4F	E0 CF	E0 69	E0 F0	69	*1
83	↑	E0 48	E0 C8	E0 75	E0 F0	75	*1
84	↓	E0 50	E0 D0	E0 72	E0 F0	72	*1
85	PgUp	E0 49	E0 C9	E0 7D	E0 F0	7D	*1
86	PgDn	E0 51	E0 D1	E0 7A	E0 F0	7A	*1
89	→	E0 4D	E0 CD	E0 74	E0 F0	74	*1
110	Esc	01	81	76	F0	76	
112	F1	3B	BB	05	F0	05	
113	F2	3C	BC	06	F0	06	
114	F3	3D	BD	04	F0	04	
115	F4	3E	BE	0C	F0	0C	
116	F5	3F	BF	03	F0	03	
117	F6	40	C0	0B	F0	0B	
118	F7	41	C1	83	F0	83	
119	F8	42	C2	0A	F0	0A	
120	F9	43	C3	01	F0	01	
121	F10	44	C4	09	F0	09	*3

Table D-1 Scan codes (set 1 and set 2) (4/4)

Cap No.	Keytop	Code set 1				Code set 2				Note
		Make		Break		Make		Break		
122	F11	57		D7		78		F0 78		*3
123	F12	58		D8		07		F0 07		*3
124	PrintSc	*6		*6		*6		*6		*6
126	Pause	*7		*7		*7		*7		*7
X	Fn	—		—		—		—		*4
X	Win	E0	5B	E0	DB	E0	1F	E0	F0 1F	
x	App	E0	5D	E0	DD	E0	2F	E0	F0 2F	

Notes:

1. * Scan codes differ by mode.
2. * Scan codes differ by overlay function.
3. * Combination with the **Fn** key gives different codes.
4. * The **Fn** key does not generate a code by itself.
5. * This key corresponds to key No. 42 in a 102-key model.
6. * Refer to Table D-6, No. 124 key scan code.
7. * Refer to Table D-7, No. 126 key scan code.

Table D-2 Scan codes with left Shift key

Cap No.	Key top	Code set 1		Code set 2	
		Make	Break	Make	Break
55	/	E0 AA E0 35	E0 B5 E0 2A	E0 F0 12 E0 4A	E0 F0 4A E0 12
75	INS	E0 AA E0 52	E0 D2 E0 2A	E0 F0 12 E0 70	E0 F0 70 E0 12
76	DEL	E0 AA E0 53	E0 D3 E0 2A	E0 F0 12 E0 71	E0 F0 71 E0 12
79	←	E0 AA E0 4B	E0 CB E0 2A	E0 F0 12 E0 6B	E0 F0 6B E0 12
80	Home	E0 AA E0 47	E0 C7 E0 2A	E0 F0 12 E0 6C	E0 F0 6C E0 12
81	End	E0 AA E0 4F	E0 CF E0 2A	E0 F0 12 E0 69	E0 F0 69 E0 12
83	↑	E0 AA E0 48	E0 C8 E0 2A	E0 F0 12 E0 75	E0 F0 75 E0 12
84	↓	E0 AA E0 50	E0 D0 E0 2A	E0 F0 12 E0 72	E0 F0 72 E0 12
85	PgUp	E0 AA E0 49	E0 C9 E0 2A	E0 F0 12 E0 7D	E0 F0 7D E0 12
86	PgDn	E0 AA E0 51	E0 D1 E0 2A	E0 F0 12 E0 7A	E0 F0 7A E0 12
89	→	E0 AA E0 4D	E0 CD E0 2A	E0 F0 12 E0 74	E0 F0 74 E0 12
X	Win	E0 AA E0 5B	E0 DB E0 2A	E0 F0 12 E0 1F	E0 F0 1F E0 12
X	App	E0 AA E0 5D	E0 DD E0 2A	E0 F0 12 E0 2F	E0 F0 2F E0 12

Note : The table above shows scan codes with the left **Shift** key. In combination with the right **Shift** key, scan codes are changed as listed below:

	With left Shift	With right Shift
Set 1	E0 AA _____	E0 B6
	E0 2A _____	E0 36
Set 2	E0 F0 12 _____	E0 F0 59
	E0 12 _____	E0 59

Table D-3 Scan codes in Numlock mode

Cap No.	Key top	Code set 1				Code set 2			
		Make		Break		Make		Break	
75	INS	E0 2A	E0 52	E0 D2	E0 AA	E0 12	E0 70	E0 F0	70 E0 F0 12
76	DEL	E0 2A	E0 53	E0 D3	E0 AA	E0 12	E0 71	E0 F0	71 E0 F0 12
79	←	E0 2A	E0 4B	E0 CB	E0 AA	E0 12	E0 6B	E0 F0	6B E0 F0 12
80	Home	E0 2A	E0 47	E0 C7	E0 AA	E0 12	E0 6C	E0 F0	6C E0 F0 12
81	End	E0 2A	E0 4F	E0 CF	E0 AA	E0 12	E0 69	E0 F0	69 E0 F0 12
83	↑	E0 2A	E0 48	E0 C8	E0 AA	E0 12	E0 75	E0 F0	75 E0 F0 12
84	↓	E0 2A	E0 50	E0 D0	E0 AA	E0 12	E0 72	E0 F0	72 E0 F0 12
85	PgUp	E0 2A	E0 49	E0 C9	E0 AA	E0 12	E0 7D	E0 F0	7D E0 F0 12
86	PgDn	E0 2A	E0 51	E0 D1	E0 AA	E0 12	E0 7A	E0 F0	7A E0 F0 12
89	→	E0 2A	E0 4D	E0 CD	E0 AA	E0 12	E0 74	E0 F0	74 E0 F0 12
X	Win	E0 2A	E0 5B	E0 DB	E0 AA	E0 12	E0 1F	E0 F0	1F E0 F0 12
X	App	E0 2A	E0 5D	E0 DD	E0 AA	E0 12	E0 2F	E0 F0	2F E0 F0 12

Table D-4 Scan codes with Fn key

Cap No.	Keytop	Code set 1		Code set 2	
		Make	Break	Make	Break
43	ENT	E0 1C	E0 9C	E0 5A	E0 F0 5A
58	L-CTRL	E0 1D	E0 9D	E0 14	E0 F0 14
60	L-ALT	E0 38	E0 B8	E0 11	E0 F0 11
121	ARROW	45	C5	77	F0 77
122	NUMERIC	45	C5	77	F0 77
123	Scrl	46	C6	7E	F0 7E

Table D-5 Scan codes in overlay mode

Cap No.	Keytop		Code set 1		Code set 2		
			Make	Break	Make	Break	
09	8	(8)	48	C8	75	F0	75
10	9	(9)	49	C9	7D	F0	7D
11	0	(*)	37	B7	7C	F0	7C
23	U	(4)	4B	CB	6B	F0	6B
24	I	(5)	4C	CC	73	F0	73
25	O	(6)	4D	CD	74	F0	74
26	P	(-)	4A	CA	7B	F0	7B
37	J	(1)	4F	CF	69	F0	69
38	K	(2)	50	D0	72	F0	72
39	L	(3)	51	D1	7A	F0	7A
40	;	(+)	4E	CE	79	F0	79
52	M	(0)	52	D2	70	F0	70
54	.	(.)	53	D3	71	F0	71
55	/	(/)	E0 35	E0 B5	E0 4A	E0 F0	4A

Table D-6 No.124 key scan code

Key top	Shift	Code set 1				Code set 2			
		Make		Break		Make		Break	
Prt Sc	Common	E0 2A	E0 37	E0 B7	E0 AA	E0 12	E0 7C	E0 F0 7C	E0 F0 12
	Ctrl +	E0 37		E0 B7		E0 7C		E0 F0 7C	
	Shift +	E0 37		E0 B7		E0 7C		E0 F0 7C	
	Alt +		54	D4		84		F0 84	

Table D-7 No.126 key scan code

Key top	Shift	Code set 1						Code set 2							
		Make						Make							
Pause	Common	E1	1D	45	E1	9D	C5	E1	14	77	E1	F0	14	F0	77
	Ctrl	E0	46	E0	C6			E0	7E	E0	F0	7E			

*: This key generates only make codes.

Appendix E Key Layout

1. United States (US) Keyboard

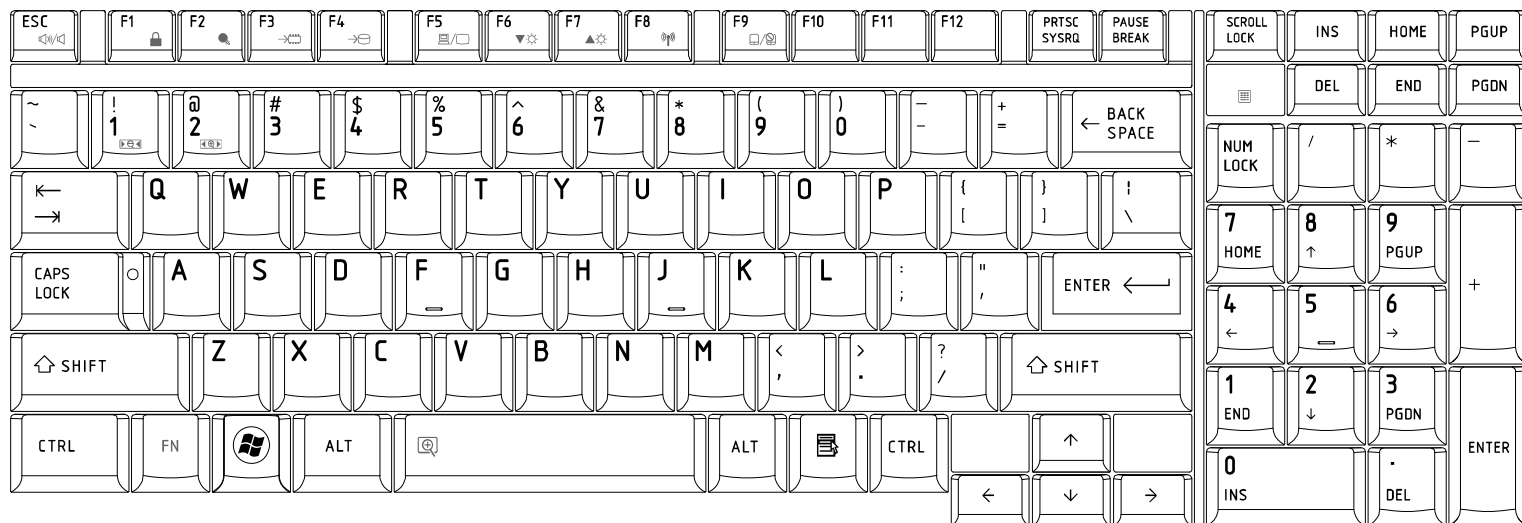

2. Traditional Chinese (CH) Keyboard

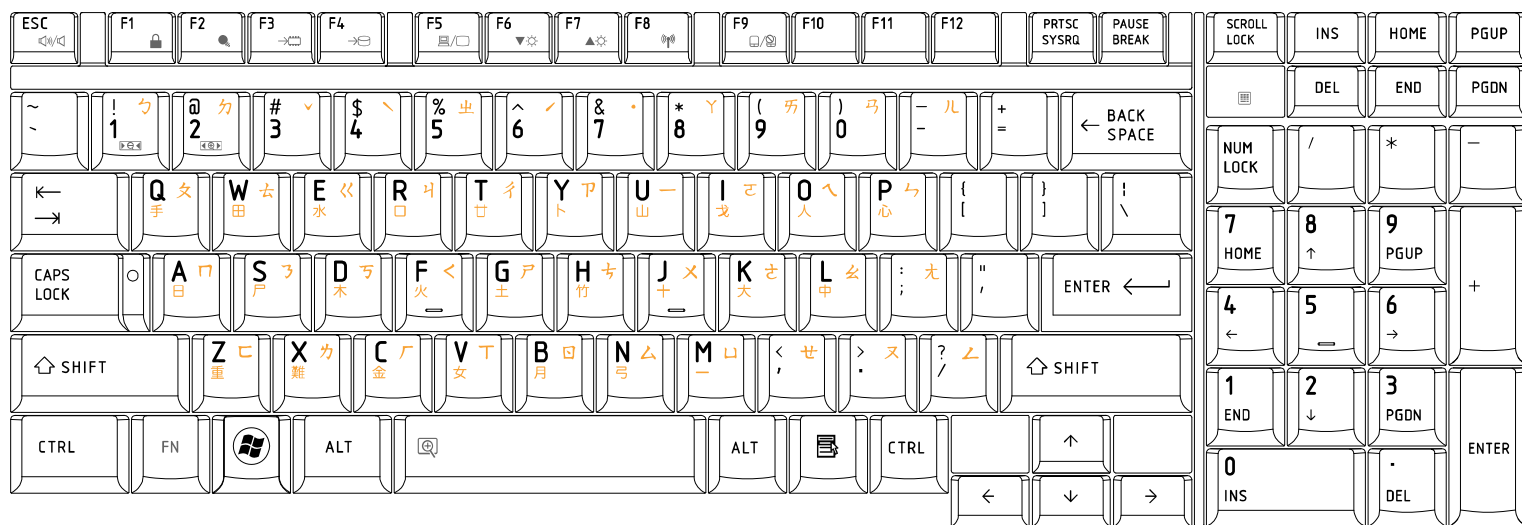

3. Thai (TI) Keyboard

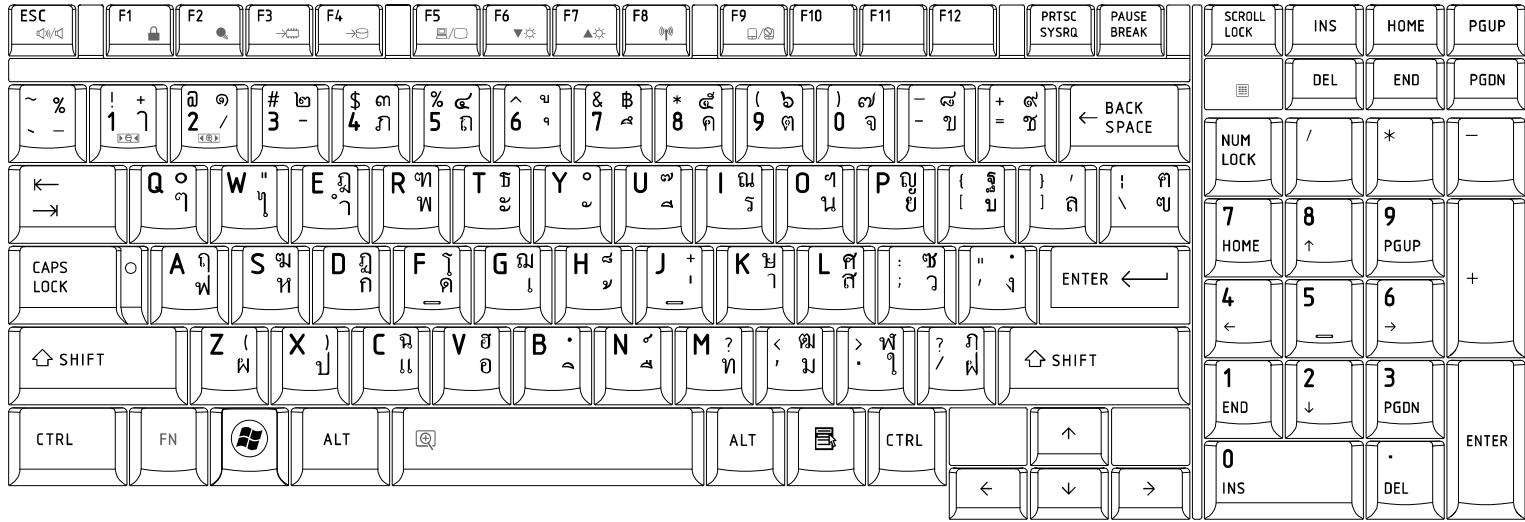

4. Korean (KO) Keyboard

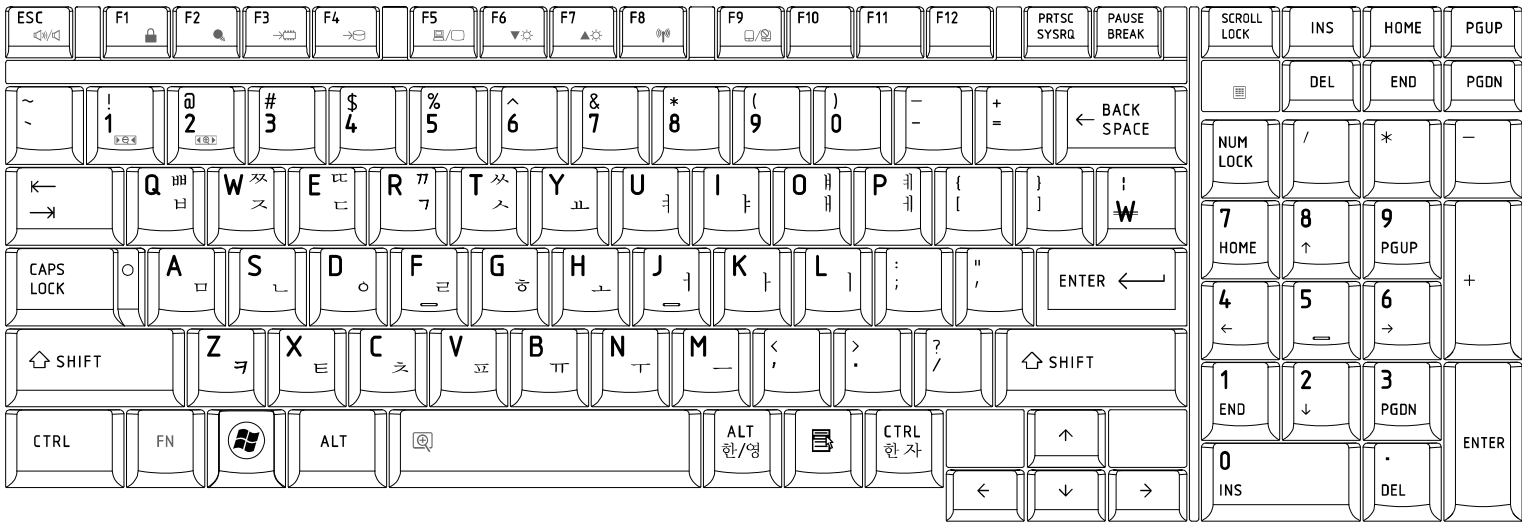

5. United Kingdom (UK) Keyboard

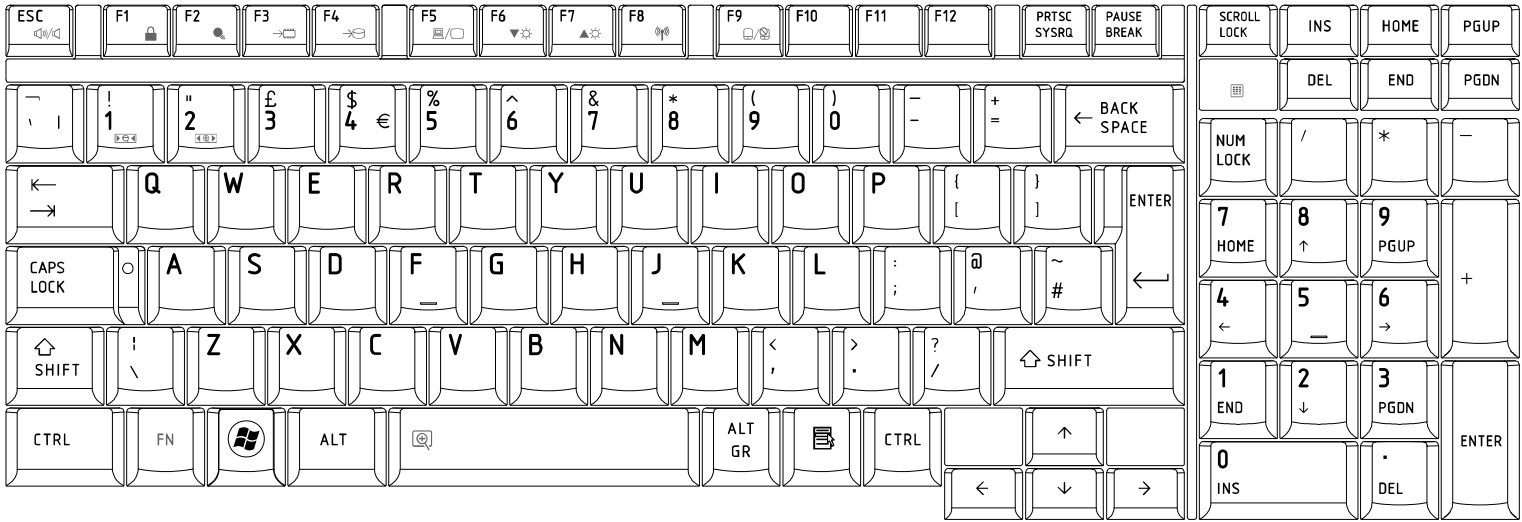

6. US International (UI) Keyboard

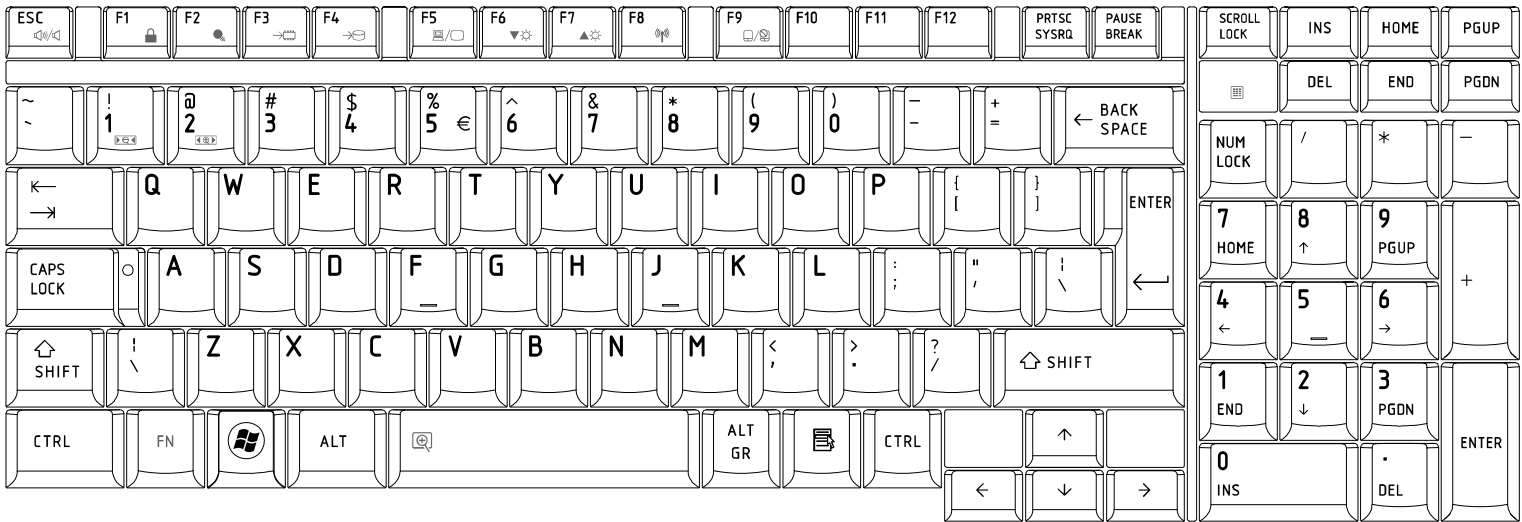

7. Hebrew (HB) Keyboard

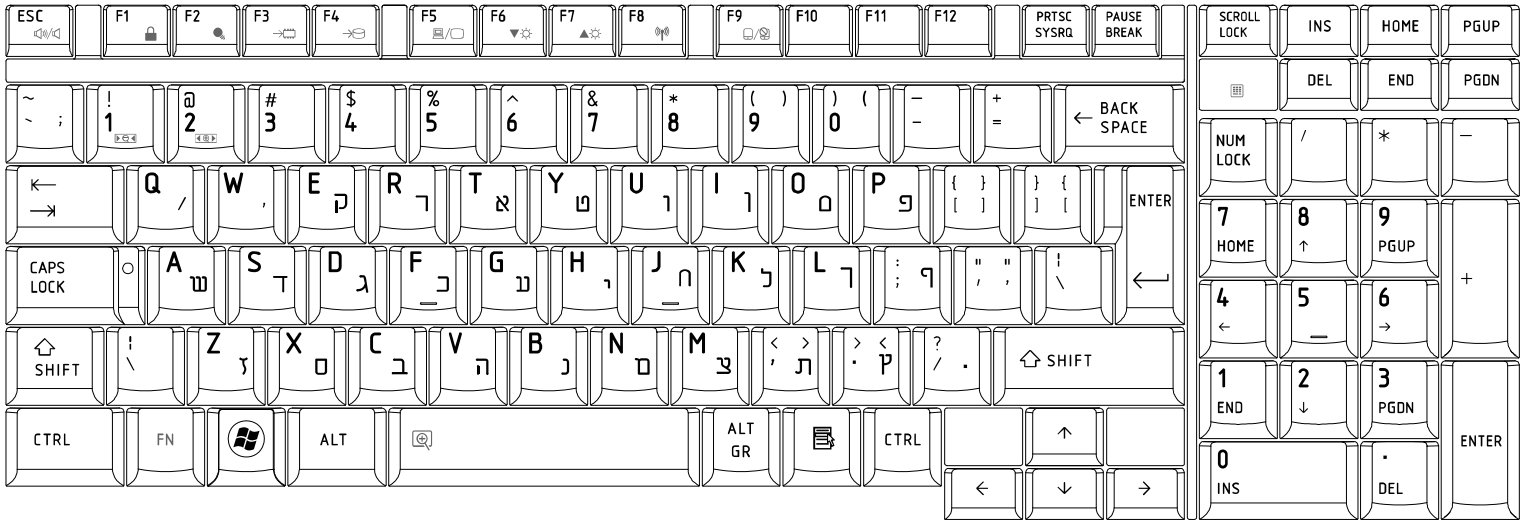

8. Danish (DM) Keyboard

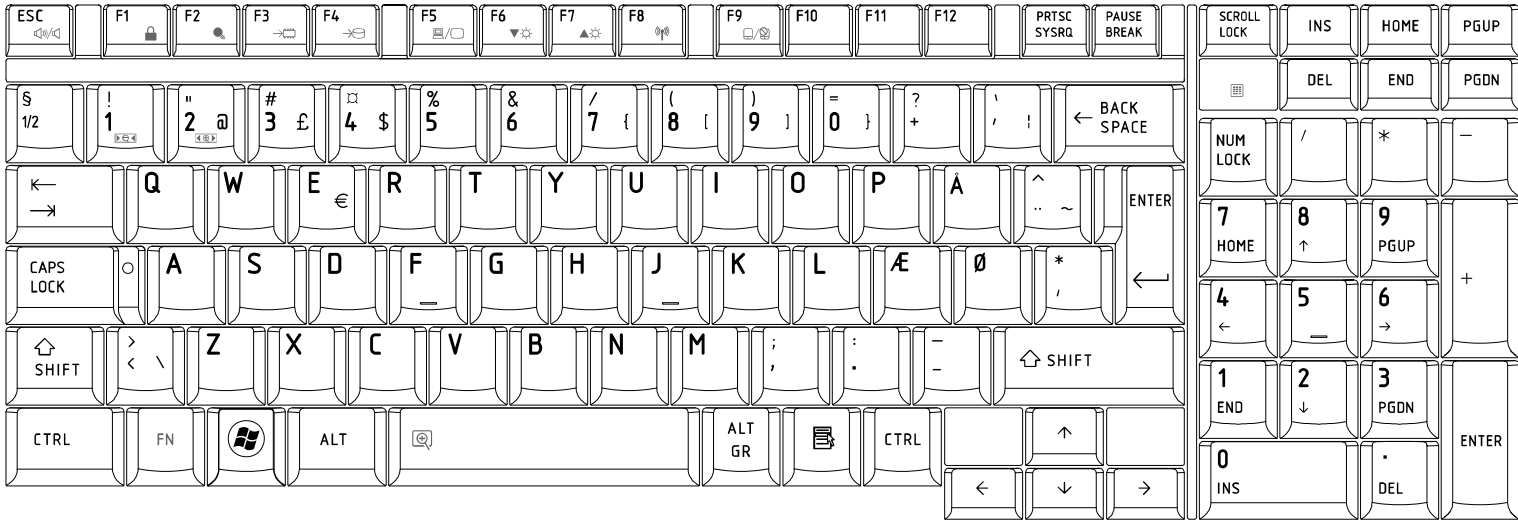

9. Swiss (SW) Keyboard

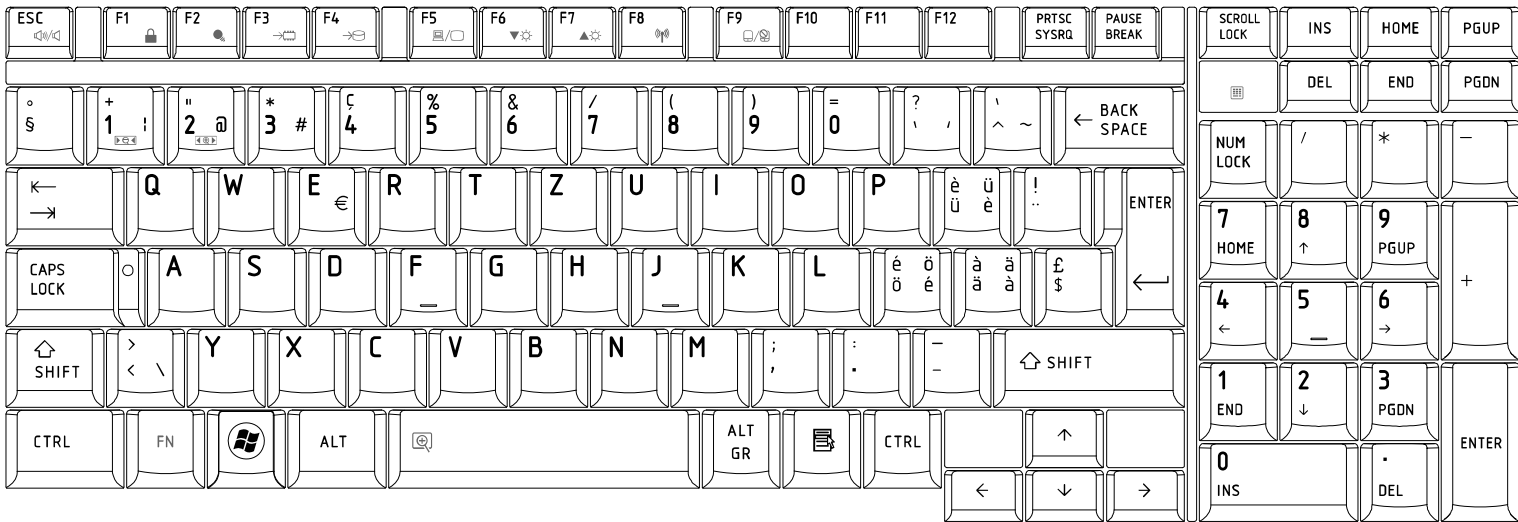

10. Arabic (ARE) Keyboard

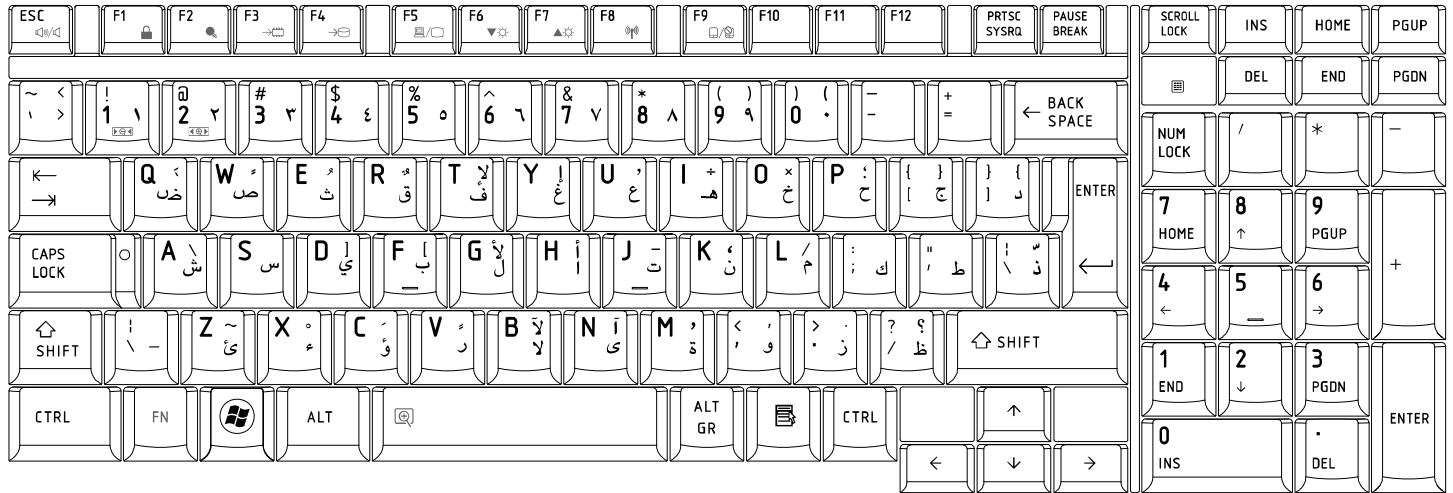

11. Czech (CZ) Keyboard

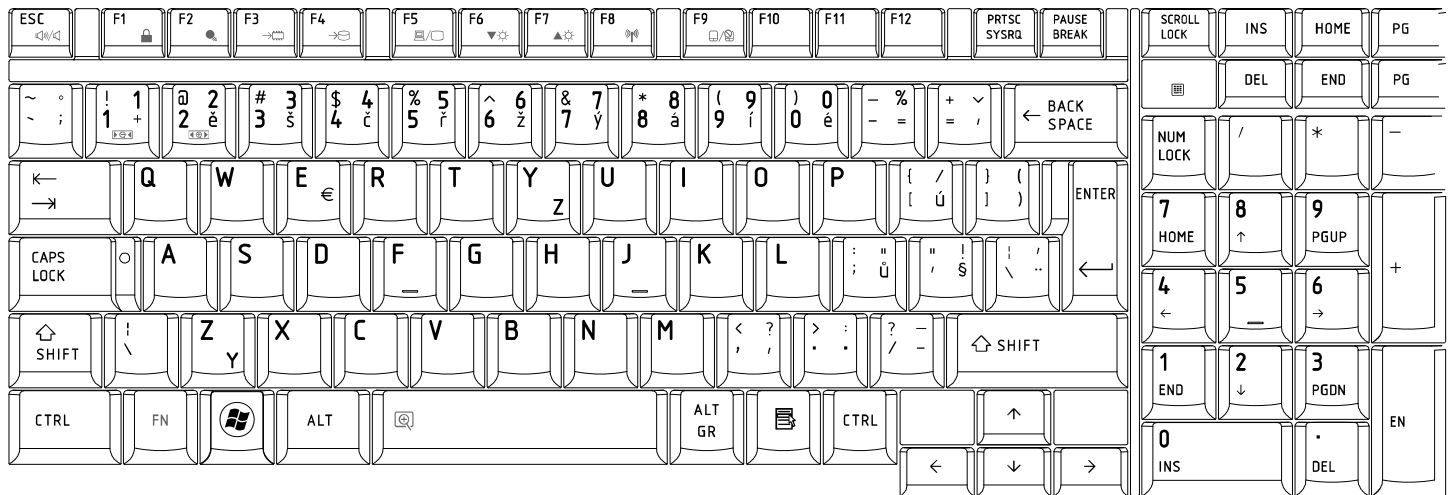

12. Russian (RU) Keyboard

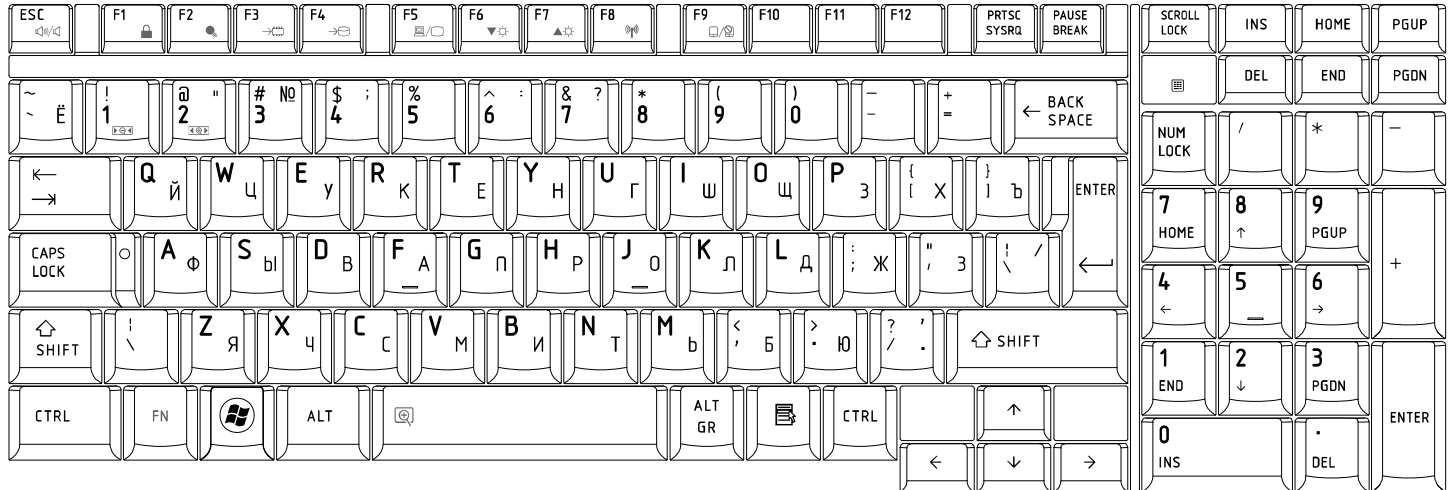

13. Portuguese (P0) Keyboard

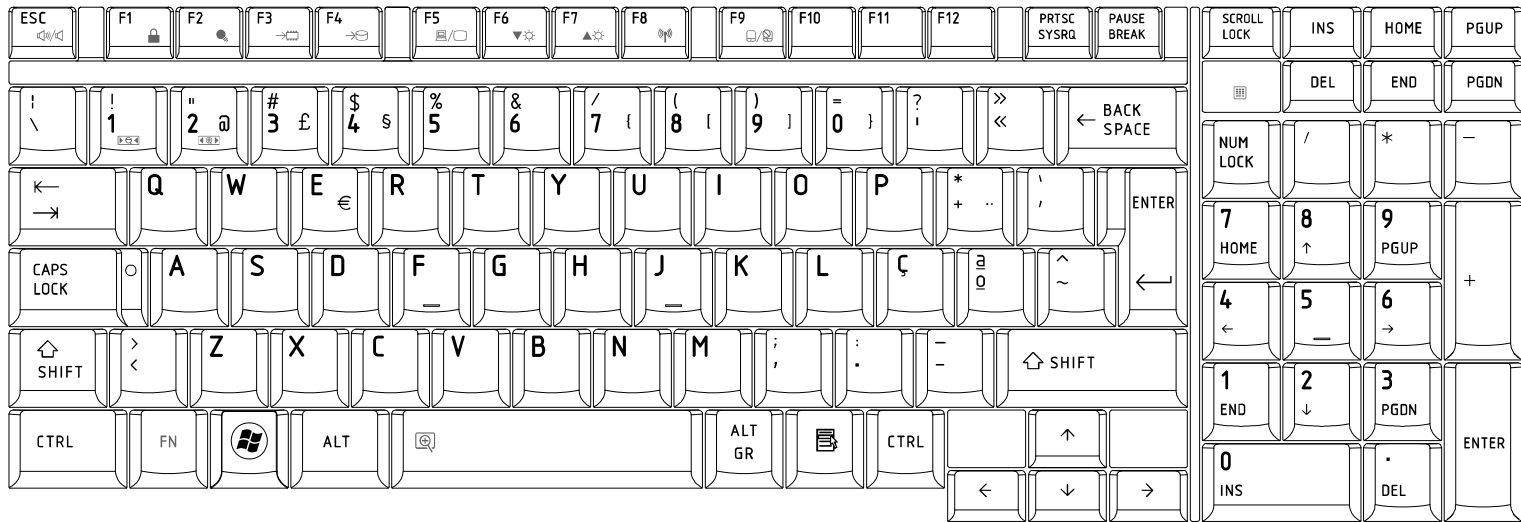

14.Slovakian (SL) Keyboard

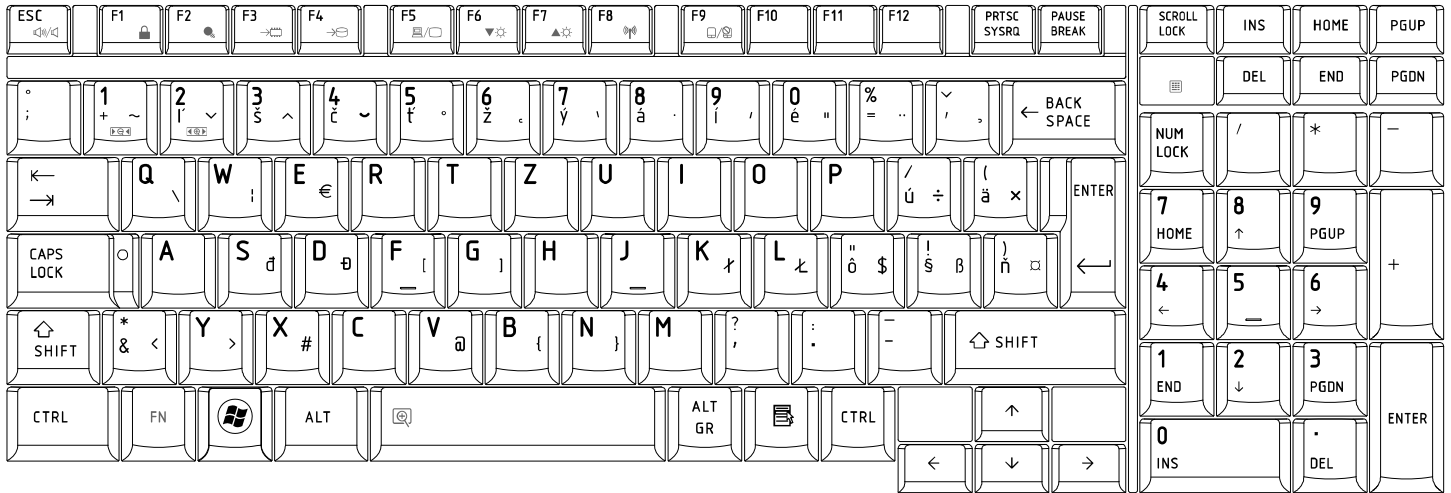

15.Italian (IT) Keyboard

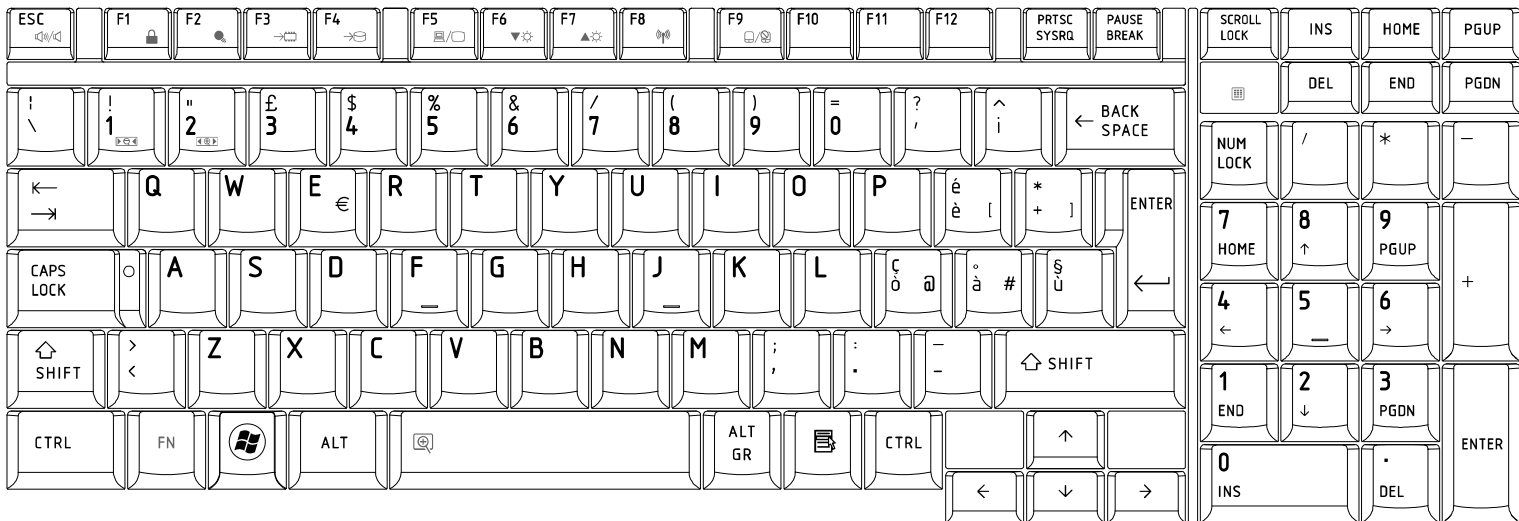

16. French (FR) Keyboard

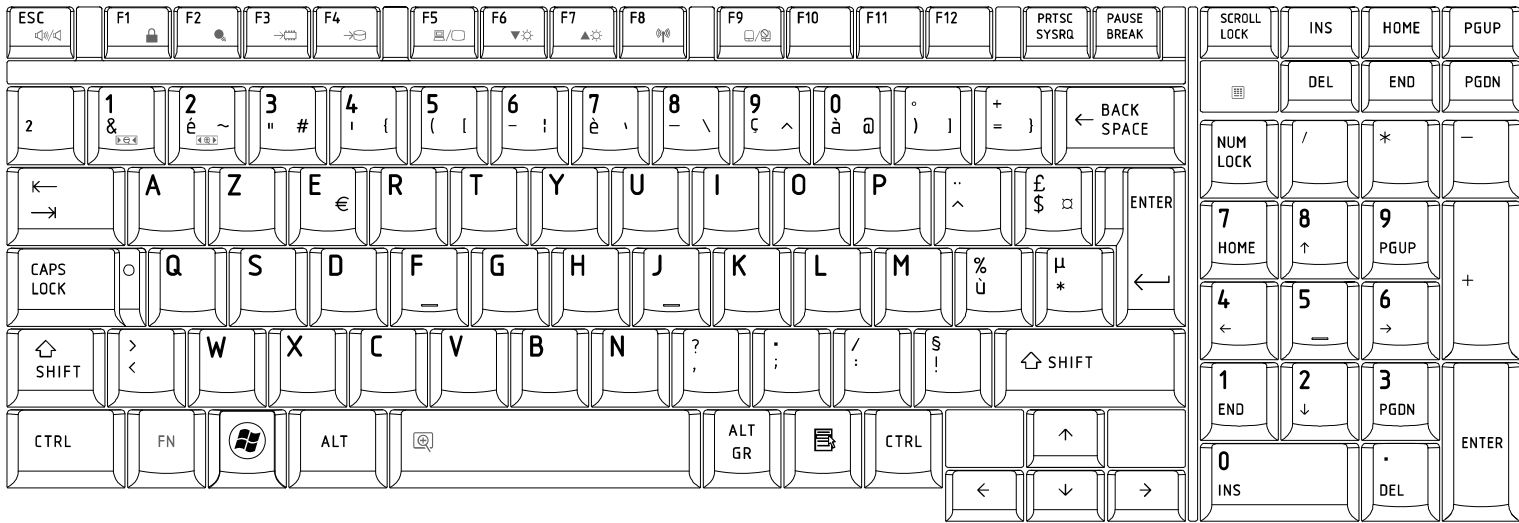

17. German (GR) Keyboard

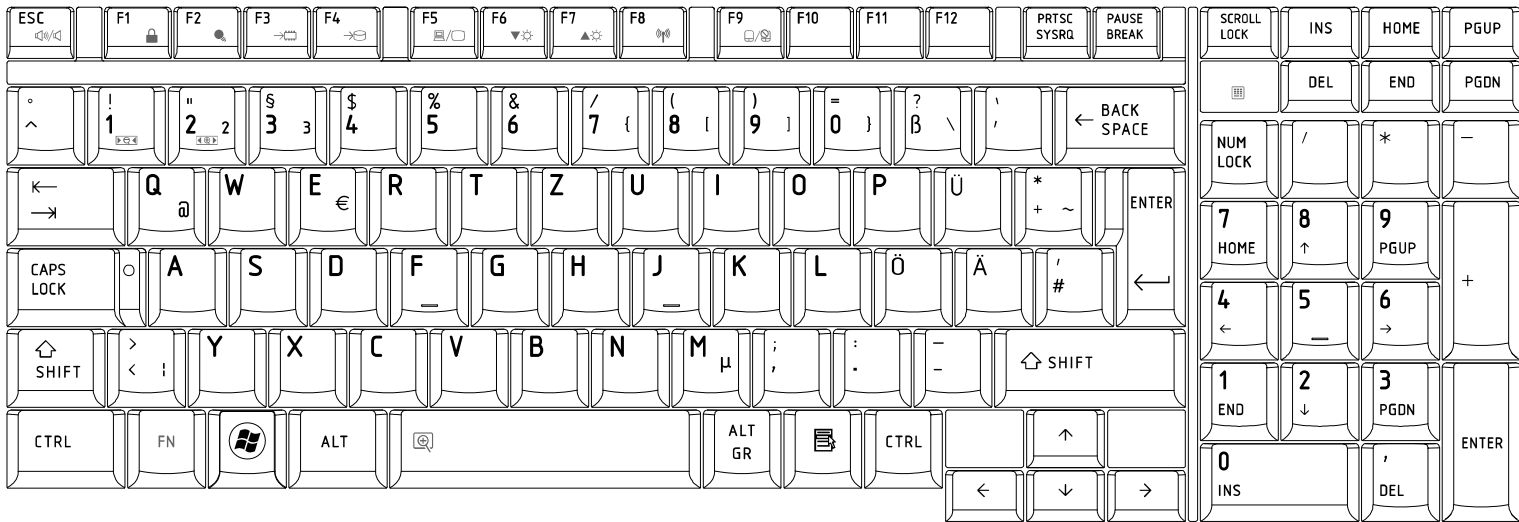

18. Greek (GK) Keyboard

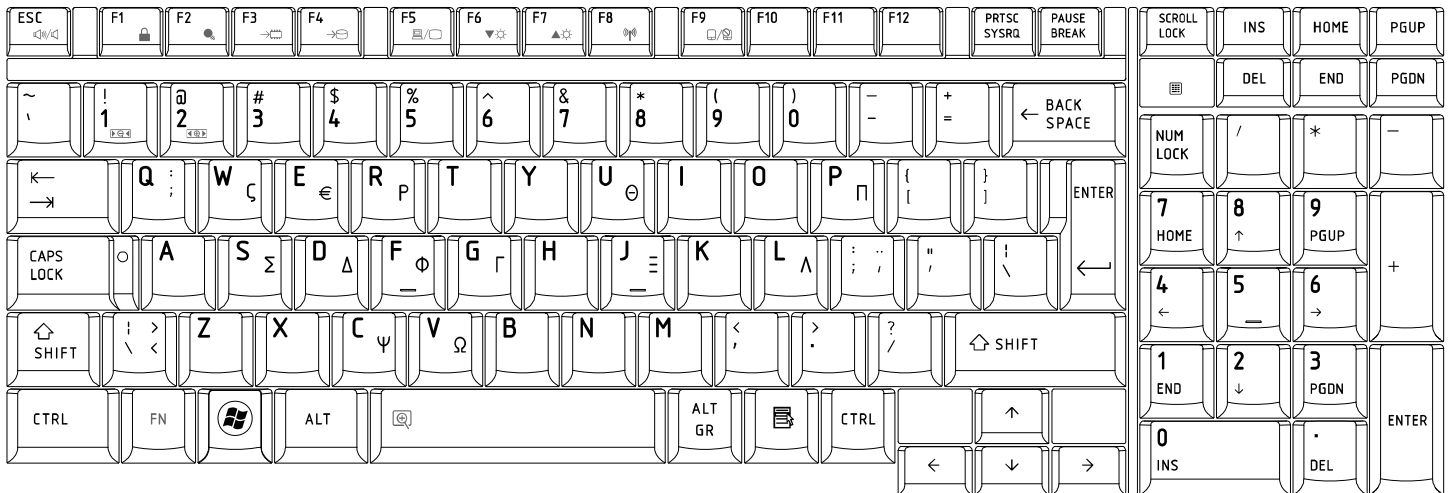

19. Hungarian (HG) Keyboard



20.Spanish (SP) Keyboard

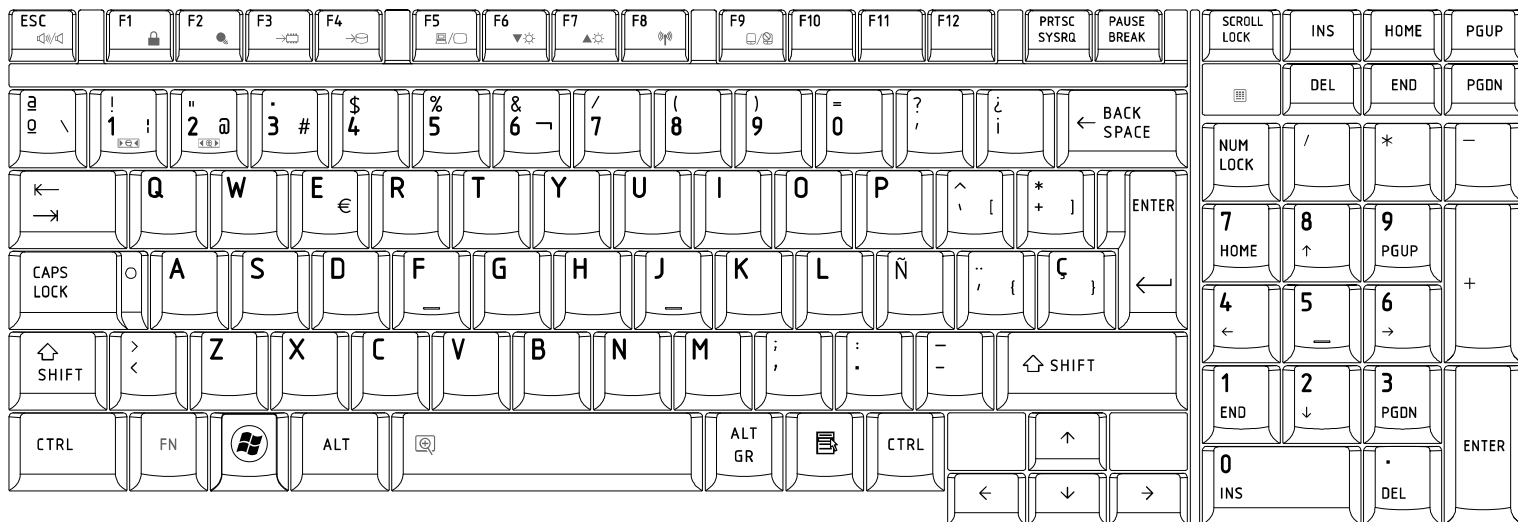

21.Turkish (TR) Keyboard



22. Turkish F (TR-F) Keyboard

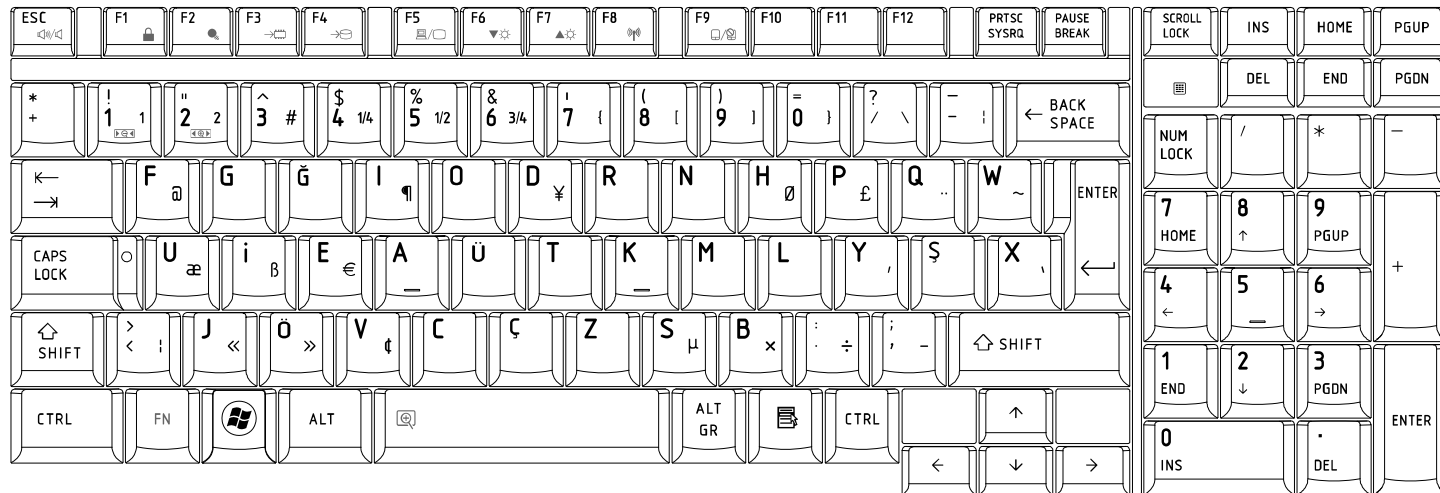

23. Swedish (SD) Keyboard

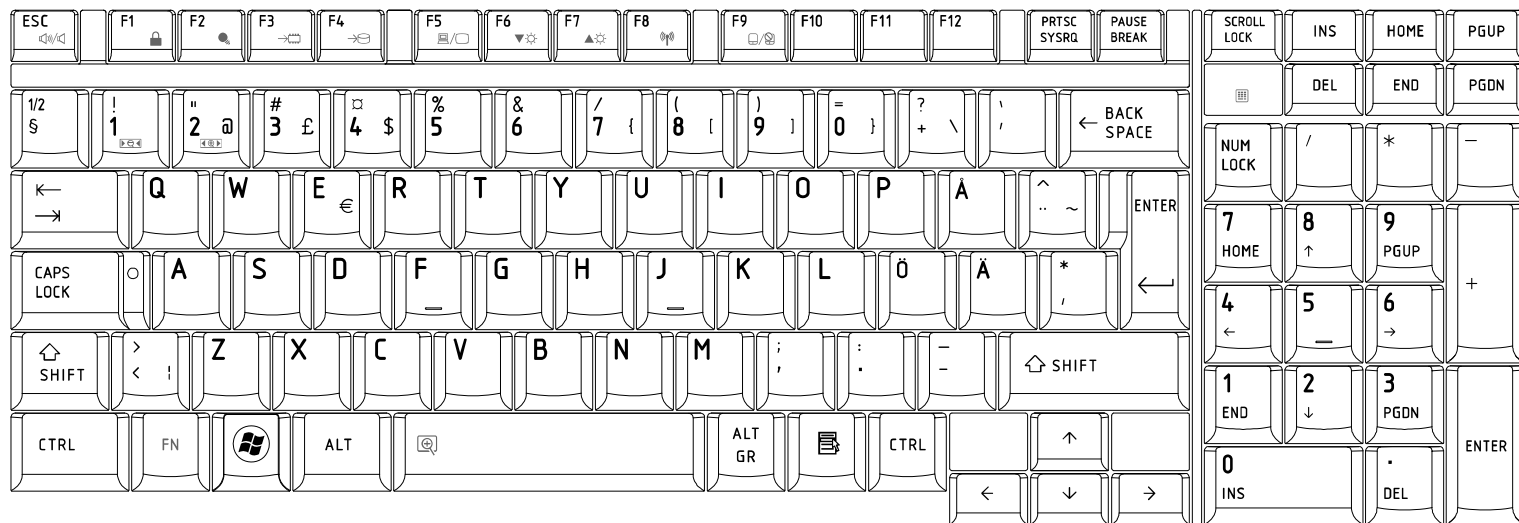

24. Belgian (BE) Keyboard

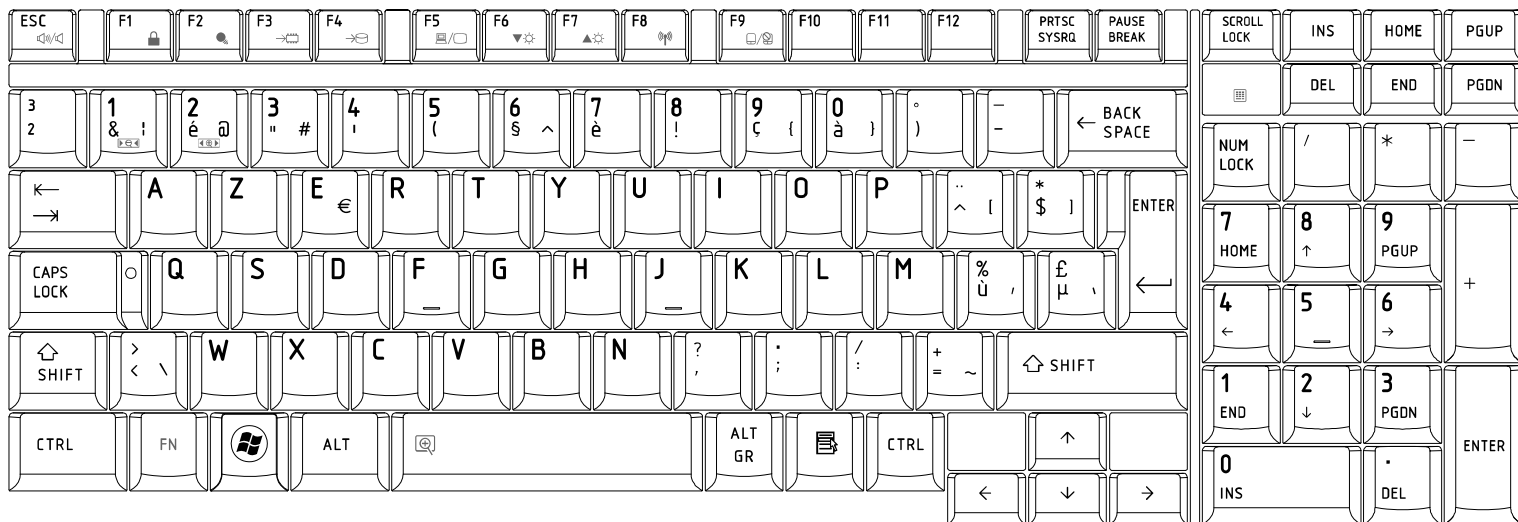

25. Yugoslavian (YU) Keyboard

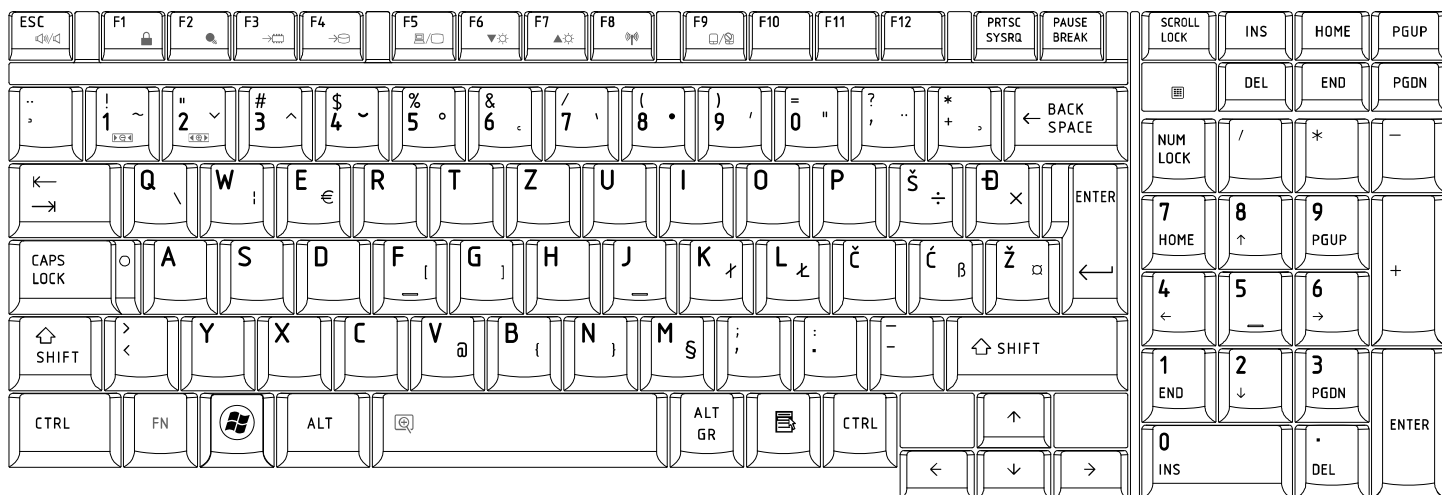

26. Norwegian (NW) Keyboard

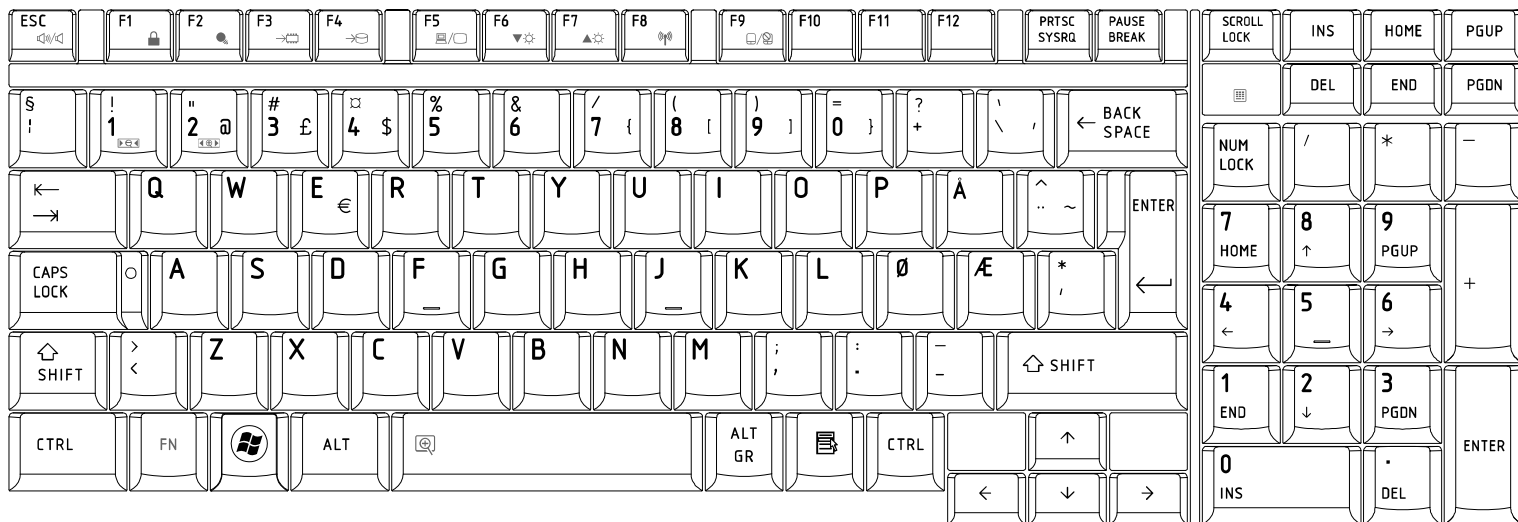

27. Scandinavian (ND) Keyboard

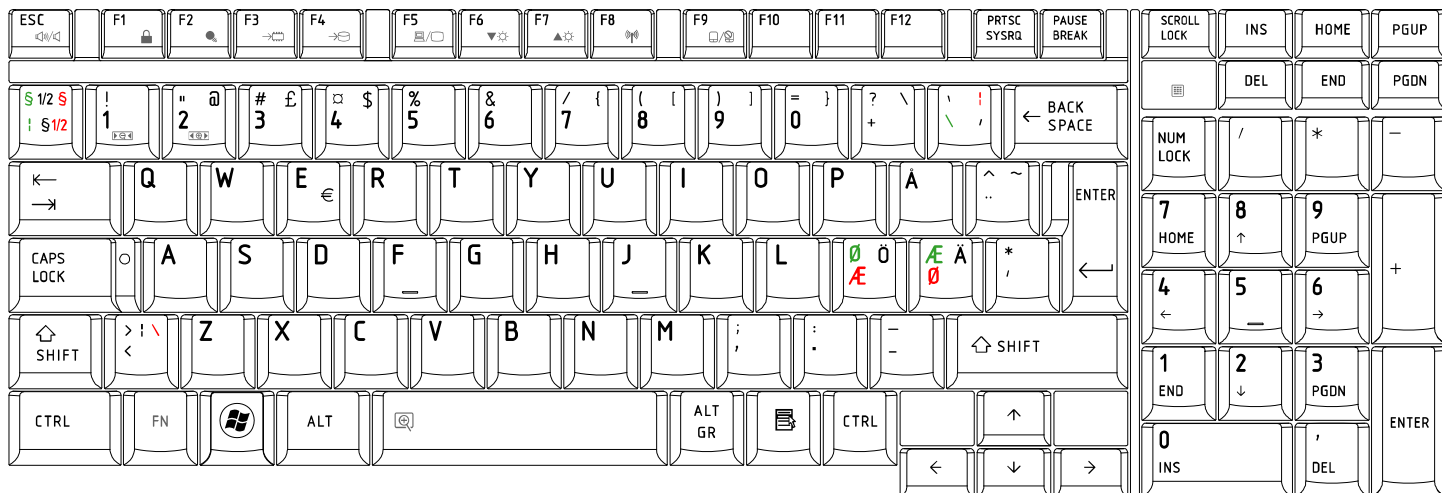

28.Canadian Multinational(AC)Keyboard



29.Canadian Bilingual (CB) Keyboard

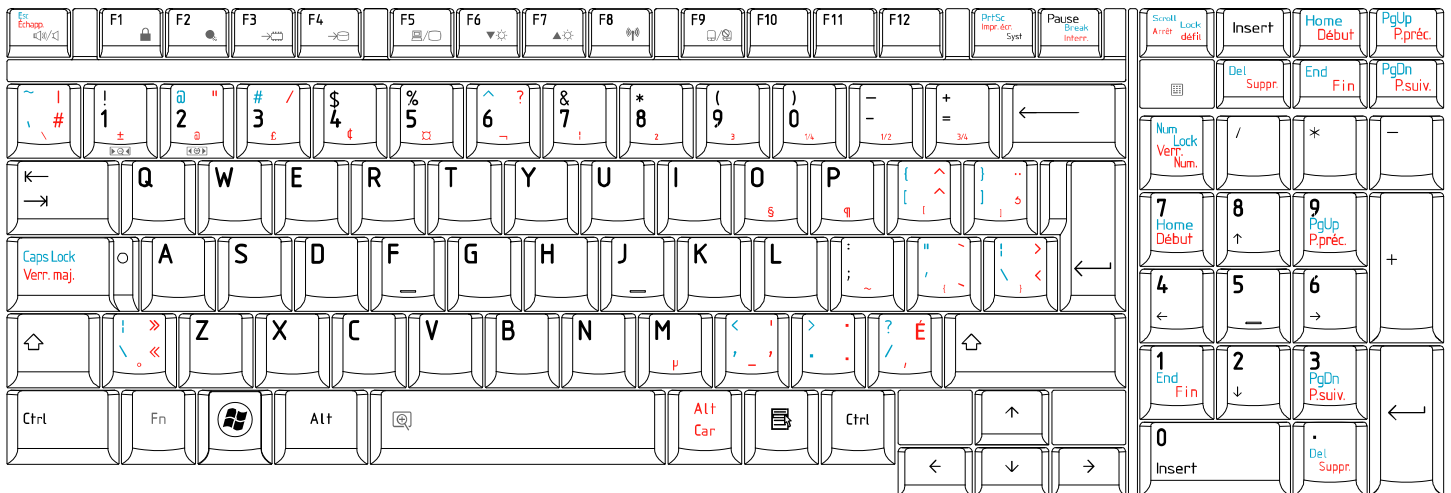

30. Japanese (JP) Keyboard



Appendix F Series Screw Torque List (KTWAA)

Table F-1 Series Screw Torque List

SCREW P/N	SCREW SPEC	Q'ty	LOCATION	SCREW TORQUE
LCD ASSY				
MACAJ0602G0	M2x2.5 (NI 白鍍)	6	LCD HINGE BRK ASSY L&R TO LCD PANEL 17W"	1.2~1.5Kgf.cm
MA0000062G0	M2.5x6 (BZn 黑鍍)	5	LCD HINGE L&R TO LCD COVER	2.5~3.0Kgf.cm
MA0000062G0	M2.5x6 (BZn 黑鍍)	5	LCD BEZEL TO COVER	2.5~3.0Kgf.cm
MB				
MAA000012G0	M2x5 (NI 白鍍)	2	HDD(H=10.2mm) CONNECTOR TO MB	1.5~2.0Kgf.cm
MAA000012G0	M2x5 (NI 白鍍)	2	BATTERY CONNECTOR TO MB	1.5~2.0Kgf.cm
MAA000012G0	M2x5 (NI 白鍍)	2	EXPRESS CARD EJECTOR TO MB	1.5~2.0Kgf.cm
MA0000060G0	M2x3 (BZn 黑鍍)	2	MDC CARD TO MB STANDOFF BTO (BTO)	1.2~1.5Kgf.cm
MA0000061G0	M2.5x4 (BZn 黑鍍)	2	WLAN CARD TO MB STANDOFF	2.0~2.5Kgf.cm
MA0000061G0	M2.5x4 (BZn 黑鍍)	2	VGA BOARD TO M/B (BTO)	2.0~2.5Kgf.cm
ODD BOARD ASSY				
MAA000012G0	M2x5 (NI 白鍍)	2	ODD CONNECTOR(H=4.5) TO ODD BOARD	1.5~2.0Kgf.cm
THERMAL MODULE				
MAA000012G0	M2x5 (NI 白鍍)	3	THERMAL FAN TO LOW	1.5~2.0Kgf.cm
AM077000C00	SPRING SCREW	4	CPU-THERMAL-SINK TO CPU-PLATE	2.0~2.5Kgf.cm
MA0000096G0	SPRING SCREW	2	VGA THERMAL SINK TO VGA-PLATE (BTO)	2.0~2.5Kgf.cm
HDD ASSY				
MCDK03030G0	M3x3 (BZn 黑鍍)	4	HDD BRACKET TO HDD	2.0~2.5Kgf.cm
ODD ASSY				
MA0000060G0	M2x3 (BZn 黑鍍)	2	ODD BRACKET TO ODD MODULE	1.2~1.5Kgf.cm

LOG UP				
MA0000060G0	M2x3 (BZn 黑鍍)	1	FUNCTION PCB TO LOG UP	1.2~1.5Kgf.cm
MA0000061G0	M2.5x4 (BZn 黑鍍)	1	TP BRACKET TO LOG UP	2.0~2.5Kgf.cm
MA0000061G0	M2.5x4 (BZn 黑鍍)	2	TP BOARD TO TP BRACKET	2.0~2.5Kgf.cm
LOG LOWER ASSY				
MA0000061G0	M2.5x4 (BZn 黑鍍)	1	SADDLE RIGHT TOP TO LOW	2.5~3.0Kgf.cm
MA0000061G0	M2.5x4 (BZn 黑鍍)	1	SADDLE LEFT TOP TO LOW	2.5~3.0Kgf.cm
MA000009KG0	SPEAKER SCREW	2	SPEAKER R TO SADDLE R	2.5~2.5Kgf.cm
MA000009KG0	SPEAKER SCREW	2	SPEAKER L TO SADDLE L	2.5~2.5Kgf.cm
MA0000061G0	M2.5x4 (BZn 黑鍍)	1	USB BOARD TO LOW	2.0~2.5Kgf.cm
MAA000012G0	M2x5 (NI 白 鍍)	2	ODD BOARD TO LOW	1.5~2.0Kgf.cm
LOGIC ASSY				
MA0000061G0	M2.5x4 (BZn 黑鍍)	2	MB TO LOG LOW	2.0~2.5Kgf.cm
MA0000062G0	M2.5x6 (BZn 黑鍍)	2	LCD HINGE R TO SADDLE R	2.5~3.0Kgf.cm
MA0000062G0	M2.5x6 (BZn 黑鍍)	2	LCD HINGE L TO SADDLE L	2.5~3.0Kgf.cm
MA0000062G0	M2.5x6 (BZn 黑鍍)	6	LOG UP TO MB TO LOG LOW	2.5~3.0Kgf.cm
MA0000062G0	M2.5x6 (BZn 黑鍍)	3	LOG LOW TO MB TO LOG UP (FRONT LEFT & FRONT MIDDLE SIDE)	2.5~3.0Kgf.cm
MA0000062G0	M2.5x6 (BZn 黑鍍)	1	LOG LOW TO LOG UP (FRONT RIGHT SIDE CLOSE ODD)	2.5~3.0Kgf.cm
MA0000062G0	M2.5x6 (BZn 黑鍍)	2	LOG LOW TO MB TO LOG UP (LEFT SIDE CLOSE FAN & EXPRESS CARD)	2.5~3.0Kgf.cm
MA0000062G0	M2.5x6 (BZn 黑鍍)	1	LOG LOW TO MB TO LOG UP (MIDDLE SIDE CLOSE MDC)	2.5~3.0Kgf.cm
MA0000061G0	M2.5x4 (BZn 黑鍍)	1	LOG LOW TO UP (HDD AREA)	2.0~2.5Kgf.cm
MA0000062G0	M2.5x6 (BZn 黑鍍)	1	LOG LOW TO USB BOARD TO LOG UP (RIGHT MIDDLE SIDE CLOSE HDD)	2.5~3.0Kgf.cm
MA0000062G0	M2.5x6 (BZn)	4	LOG LOW TO SADDLE	2.5~3.0Kgf.cm

	黑鍍)		TO LOG UP (LEFT REAR SIDE)	
MA0000062G0	M2.5x6 (BZn 黑鍍)	4	LOG LOW TO SADDLE TO LOG UP (RIGHT REAR SIDE)	2.5~3.0Kgf.cm
MA0000061G0	M2.5x4 (BZn 黑鍍)	3	LOG LOW TO UP (BATTERY AREA)	2.0~2.5Kgf.cm
MA0000062G0	M2.5x6 (BZn 黑鍍)	1	LOG LOW TO UP (REAR MIDDLE SIDE)	2.5~3.0Kgf.cm
MA0000062G0	M2.5x6 (BZn 黑鍍)	1	LOG LOW TO ODD BRACKET	2.5~3.0Kgf.cm
MA0000061G0	M2.5x4 (BZn 黑鍍)	2	KEYBOARD TO UP	2.0~2.5Kgf.cm
MA0000062G0	M2.5x6 (BZn 黑鍍)	1	HDD DOOR TO LOG LOW	2.5~3.0Kgf.cm
MA0000035G0	M2.5*5 半牙 (BZn 黑鍍)	1	RAM DOOR TO LOW (FIX ON DOOR)	2.0~2.5Kgf.cm

Appendix G Reliability

The following table shows MTBF (Mean Time Between Failures) for each component.

Table G-1 MTBF

Component	Time (hours)
LCD	10,000
Keyboard	60,000
HDD	300,000
Optical (DVD/CD) drive	60,000
AC adaptor	60,000